

WISENET

2M Wi-Fi 홈카메라

제품 사용 설명서

HNB-E60

2M Wi-Fi 홈카메라

제품 사용 설명서

Copyright

©2020 Hanwha Techwin Co., Ltd. All rights reserved.

Trademark

여기에 기재된 상표는 모두 등록된 것으로 이 매뉴얼에 기재된 이 상품의 이름과 다른 상표는 각 회사로부터 등록된 상표입니다.

Restriction

이 문서는 저작권에 의해 보호됩니다. 어떠한 경우에도, 공식적인 동의 없이 이 문서의 전체 혹은 부분을 복제, 배포, 수정할 수 없습니다.

Disclaimer

한화테크윈(주)는 이 문서에 수록된 정보의 완결성과 정확성을 검증하기 위해 최 대한 노력을 하였으나 이에 대해 보증하지는 않습니다. 문서의 사용 결과에 따른 책임은 전적으로 사용자에게 있습니다. 한화테크윈(주)는 사전 예고 없이 이 문서의 내용을 변경할 수 있습니다.

사용지침 및 보증

이 기기는 가정용(B급) 전자파적합기기로서 주로 가정에서 사용하는 것을 목적으로 하며, 모든 지역에서 사용할 수 있습니다.

해당 무선설비는 전파혼신가능성이 있으므로 인명안전과 관련된 서비스는 할 수 없습니다.

지침 및 보증

제조사는 본 제품의 무단 개조에 의해 발생하는 손실이나 라디오/TV 간섭에 대해 책임지지 않습니다.

그와 같은 무단 개조는 사용자의 사용권한뿐만 아니라 제품에 대한 품질 보증 또한 무효화시킵니다.

경고

- 본 제품은 반드시 성인이 조립 및 설치해야 합니다.
- 사용하기 전에 본 설명서의 모든 지침을 숙독하고 본 설명서와 제품에 표시된 작동 지침 및 경고를 준수하세요.
- 전원 코드가 얽히지 않도록 유아 침대나 기타 유아용 가구 주변으로부터 멀리 두세요. 제품과 전원 코드를 어린이 손이 닿지 않는 곳에 설치하세요.
- 특히 전원 코드는 어린이의 손이 닿지 않는 곳에 주의깊게 설치해야 합니다.
- 제품을 욕조, 싱크대, 세탁기, 젖은 지하실 등 습기 많은 환경에서 사용하지 마세요.
- 본 제품은 실내용으로 설계되었습니다.
- 본 제품은 의류용으로 설계되지 않았으며 사용시 성인의 보호 감찰이 필요합니다.
- 제품의 과열을 방지하기 위해 제품을 직사일광에 노출하거나 난로, 라디에이터, 전기 레인지나 오븐같은 조리기구 및 오디오 증폭기, TV 등과 같은 기타 방열 기구 등의 주변에 설치하지 마세요.
- 제품을 사용하는 동안 환기가 잘 되도록 유지하세요.
- 제품 설치 시 건물 기둥이나 가구가 환기를 차단하지 않도록 주의하세요.
- 제공된 전원 어댑터를 사용하세요. 인증되지 않은 어댑터를 사용할 경우 제품이 손상될 수 있습니다. 전원 어댑터에는 가정용 정격 전원을 연결/사용해야 합니다.

- 어댑터 케이블 주위에 날카롭고 끝이 뾰족한 물건을 두지 마세요. 케이블이 손상될 수 있습니다.
- 어댑터를 벽면 콘센트에 꽂거나 뽑을 경우 케이블이 노출된 부분은 절대 잡지 마세요.
- 어댑터 전원 코드용 연장선을 사용하지 마세요. 케이블이 꼬일 수 있습니다.
- 한화테크윈의 공인된 서비스 직원만이 제품 서비스를 담당할 수 있습니다.
- 본 제품은 어린이를 보호 관찰할 경우 제품이 어린이 손에 닿지 않도록 주의하세요.
- 본 제품에는 호흡 장애 유발 가능성이 있는 부품이 일부 포함되어 있습니다.
- 제품의 주변 장치 및 소형 부품들은 어린이 손이 닿지 않는 곳에 보관하세요.
- 본 제품은 어린이에 대한 인간적 감독 의무를 대체하기 위한 것이 아닙니다.
- 본 제품은 어린이의 돌발적이고 갑작스러운 움직임을 어른에게 즉각 통지하는 기능을 동반하고 있지 않으며 정기적인 점검 및 직원에 의한 감독관리가 필요합니다.
- 본 제품의 무선 성능 사양을 충족하기 위해서 동일 장소에서 2대 이상 사용할 경우 서로 간 거리를 최소 1m 이상 띄워 주세요.
- 다른 용도로 사용하던 Micro SD 카드를 카메라에 장착하면 데이터가 삭제될 수 있으니 주의하세요.

목차

시작하기

제품 특징	5
제품 및 부속품 확인	6
각 부분의 명칭 및 기능	7

설치 및 네트워크 연결

설치	9
네트워크 연결 및 설정	10

모니터링

등록	13
인터페이스 살펴보기	18
화면 모니터링하기	21

카메라 설정

카메라 설정하기	23
----------------	----

부록

제품 사양	33
문제해결	35
OPEN SOURCE ANNOUNCEMENT	36

시작하기

01

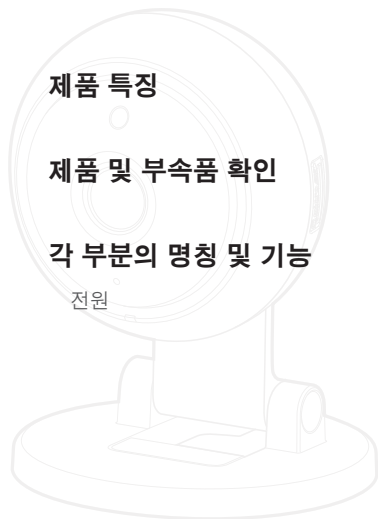

제품 특징

- **Wi-Fi 전용 제품**
 - Wi-Fi 연결을 통해 카메라를 등록합니다.
- **간편한 설치**
 - 구글 플레이스토어 또는 앱스토어에서 SmartCam Lite 앱을 다운받아 설치하세요.
 - 앱의 간단한 QR 스캔만으로 무선 공유기와 제품을 쉽게 연결할 수 있습니다.
- **실시간 원격 모니터링**
 - 언제 어디서건 인터넷만 가능하다면 언제라도 원격 모니터링이 가능합니다.
 - 스마트폰과 같은 모바일 기기로 모니터링을 할 수 있습니다.
- **실시간 알람**
 - 동작과 소리가 감지되면 스마트폰을 통해 실시간으로 알람이 울립니다.
- **SD카드 저장**
 - 이벤트 발생 시 또는 사용자가 직접 영상을 SD 카드에 저장할 수 있습니다.
- **양방향 대화**
 - 카메라에 내장된 스피커와 마이크로 앱을 통해 스마트폰과 양방향 대화가 가능합니다.

5

6

7

8

제품 및 부속품 확인

제품 구입 시 제품 패키지에 모든 구성품이 들어 있는지 확인하세요.

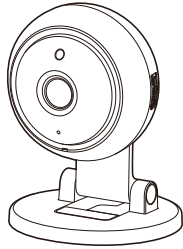

카메라

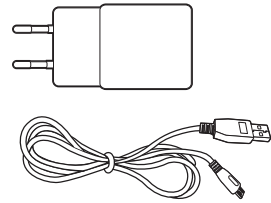

전원 어댑터&케이블

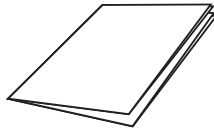

간편 설명서

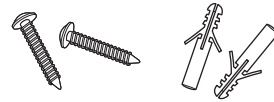

설치 나사 /
플라스틱 앵커

각 부분의 명칭 및 기능

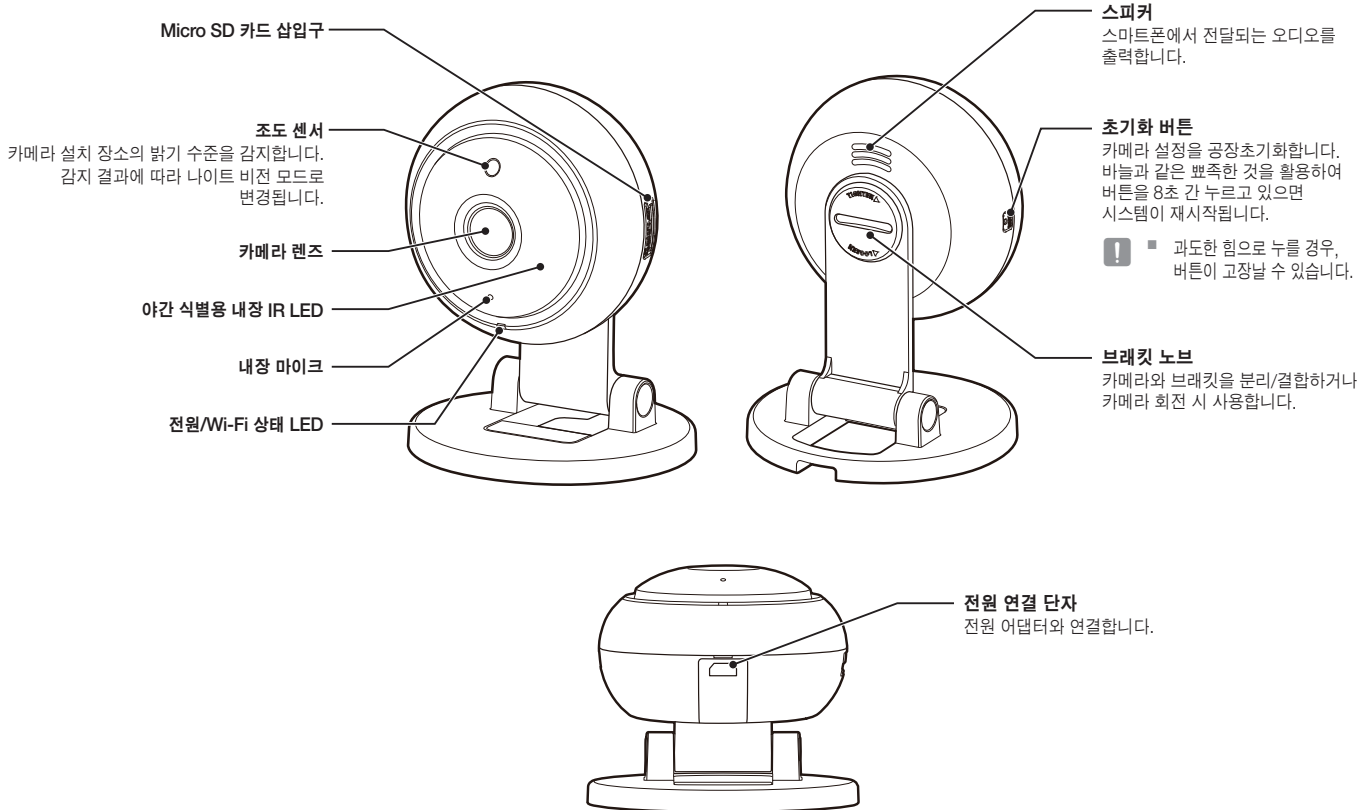

전원

카메라 전원 어댑터를 그림과 같이 브래킷에 케이블을 통과시킨 후 카메라의 전원 단자와 연결하세요.



- 제공된 전원 어댑터를 사용하세요. 제공된 전원 어댑터 이외의 어댑터 사용 시 제품이 제대로 작동하지 않을 수 있습니다.
- 카메라가 완전히 켜지는데 약 40초 정도 걸립니다.
- 카메라가 완전히 켜지면 LED 색상이 빨간색으로 깜박입니다.

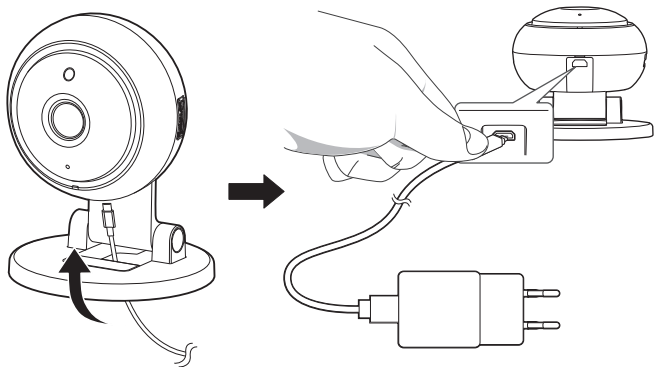

❖ LED 상태

LED 색상은 동작 상태에 따라 달라집니다.

다음 표를 참고하세요.

색상	상태
빨간색	카메라 부팅 초기화 버튼을 3초 동안 길게 누름
빨간색 깜빡임	부팅 완료 네트워크 연결 대기
파란색 깜빡임	Wi-Fi 정보를 받아서 연결 시도
파란색	Wi-Fi 연결 설정 완료
초록색	모바일 앱에 접속되어 있음
노란색	무선 공유기 연결 실패
보라색	펌웨어 업그레이드
흰색	초기화 버튼을 8초 동안 길게 누름

설치 및 네트워크 연결

02

설치

주의 사항

1. Wi-Fi 신호가 잡히고 간섭이 없는 곳에 카메라를 설치하세요.
2. 가습기 주변과 같이 습한 곳을 피하세요.
3. 직사광선, 강한 빛이나 먼지가 없고 시야가 선명한 곳에 설치하세요.
4. 장애물이 많은 곳에 설치하지 마세요.
5. 항상 렌즈를 깨끗하게 유지하세요.
먼지를 닦을 때에는 부드러운 천을 사용하세요.
6. 당사에서 권장하지 않는 방법으로 제품을 설치/분해하는 경우 제품의
기능/성능을 보장할 수 없습니다.

설치

9

- 주의 사항

9

네트워크 연결 및 설정

10

- 주의 사항
- 나사를 이용한 벽면/천장 설치
- 카메라 각도 조정하기

10

10

12

네트워크 연결 및 설정

주의 사항

- 통신 환경에 의해 무선 네트워크 접속에 실패할 수도 있습니다.
- 네트워크 설정 및 비밀번호에 대해 자세한 내용을 보려면 네트워크 관리자나 서비스 제공업체에 문의하세요.
- 사용자 인증이 필요한 특정 인터넷 서비스의 경우 서비스가 제공되지 않을 수도 있습니다. 이 경우 서비스 제공업체에 문의하세요.
- 인증되지 않은 네트워크에 접근하지 마세요.
- 무선 공유기에서 멀어질수록 네트워크 연결 대기 시간이 길어집니다.
- 선택된 무선 네트워크 접근에 실패한 경우 다른 무선 네트워크에 접근해 보세요.
- 공유기 또는 무선 연결에 대해 자세한 내용을 보려면 공유기 설명서를 참조하거나 공유기 제조사에 문의하세요.
- 카메라가 복수의 무선 연결 네트워크 환경에 설치된 경우 네트워크 전송량 부하에 따라 일부 영상 패킷이 손실될 수 있습니다.
- 이상의 상황뿐만 아니라 네트워크 상황에 따라 네트워크 지연이나 중단이 발생할 수 있습니다.
- 일부 공유기에서 호환성 문제가 발생할 수 있습니다.

나사를 이용한 벽면/천장 설치

❖ 브래킷 방향 변경하기

1. 카메라 뒷면의 브래킷 노브를 시계 반대 방향(왼쪽)으로 돌려 분리하세요.

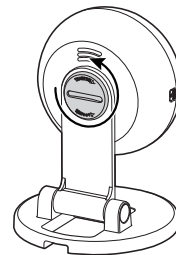

2. 아래 그림과 같이 브래킷 노브와 카메라의 위치를 바꾸고 브래킷 노브를 끼운 후 시계 방향(오른쪽)으로 돌려 고정하세요.

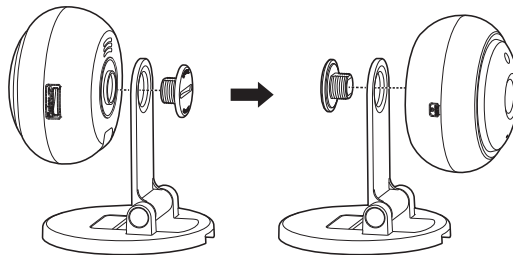

❖ 목재 벽면에 설치할 경우

1. 카메라의 브래킷 스탠드에 있는 고무패킹을 제거하세요.

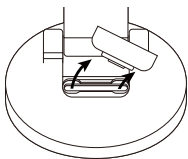

2. 설치하려는 벽면에 2개의 나사를 이용하여 제품을 벽에 고정시키세요.



- 카메라 설치 시 케이블이 눌리지 않도록 브래킷 스탠드의 배선 홈 사이로 케이블을 넣으세요.

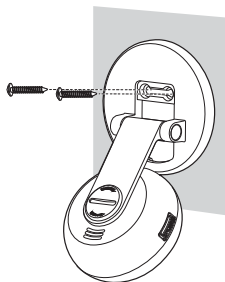

3. 고무패킹을 다시 원래 위치에 덮어주세요.

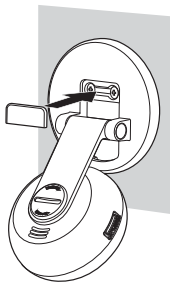

❖ 콘크리트 벽면에 설치할 경우

1. 카메라의 브래킷 스탠드에 있는 고무패킹을 제거하세요.

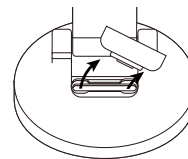

2. 먼저 설치하려는 벽면에 브래킷 스탠드를 대고 나사가 들어갈 위치를 표시하세요.

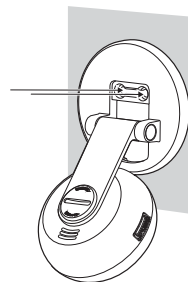

3. 표시된 위치에 직경 5mm 콘크리트용 드릴 비트와 드릴을 이용하여 약 3cm 깊이의 구멍을 뚫으세요.

- 작업 후 구멍 안의 부스러기 등을 털어내세요.



- 드릴 작업시 부상당하지 않도록 주의하세요.

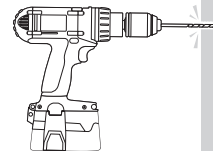

4. 뚫은 구멍에 앵커를 삽입한 후, 앵커의 뒷면을 망치 또는 고무 망치를 이용하여 가볍게 때려 끝까지 삽입하세요.

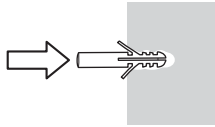

5. 앵커가 삽입된 구멍 2곳에 나사를 이용하여 제품을 벽에 고정시키세요.



- 카메라 설치 시 케이블이 눌리지 않도록 브래킷 스탠드의 배선 홈 사이로 케이블을 넣으세요.

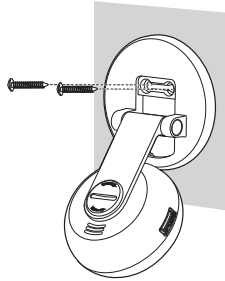

6. 고무패킹을 다시 원래 위치에 덮어주세요.

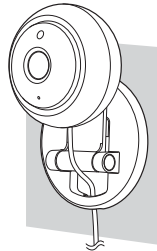
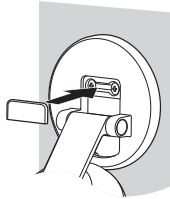

카메라 각도 조정하기

- 브래킷 노브를 시계 반대 방향으로 돌려 느슨하게 한 후 카메라를 원하는 방향으로 회전시키세요.
- 브래킷 노브를 시계 방향으로 돌려 조이세요.



- 브래킷을 앞, 뒤로 밀거나 당겨 카메라 촬영 각도를 적절히 조정하세요.



- 브래킷의 힌지가 헐거워지면 고무 커버를 제거하고 드라이버로 나사를 조여 카메라 방향을 조정하세요.

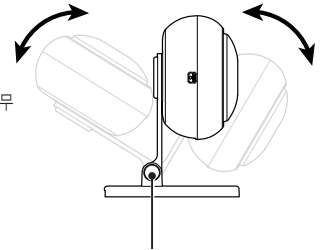

각도 조절 힌지

모니터링

03

등록

모바일 앱 OS 사양	13
스마트캠 시작하기	13
카메라 등록하기	14

인터페이스 살펴보기

홈 화면	18
메뉴	19
이벤트	20

화면 모니터링하기

실시간 모니터링 화면	21
재생 화면	22

등록

본 제품은 스마트폰을 통해서 카메라 등록 및 모니터링이 가능합니다

모바일 앱 OS 사양

iOS 10.0 이상
Android OS 6.0 이상

스마트캠 시작하기

1. 구글 플레이스토어 또는 앱스토어를 실행하세요.
2. **SmartCam Lite** 앱을 설치한 후 실행하세요.

3. <회원가입>을 누른 후 회원가입 정보를 입력하세요.

스마트캠 앱의 회원가입 화면입니다. 화면 상단에는 '←' 버튼과 '회원가입' 타이틀이 있습니다. 입력 필드는 '이메일', '비밀번호', '비밀번호 확인' (영문자 8~13), '이메일 인증 코드' (코드전송 버튼) 순으로 구성되어 있습니다. 화면 하단에는 '취소'와 '회원가입' 버튼이 있습니다.

- 이메일 : 사용 중인 이메일 주소를 **SmartCam Lite**의 로그인 계정으로 입력하세요.
회원 가입에 필요한 인증 코드를 받거나, 비밀번호를 잊었을 때 새로운 비밀번호를 받기 위해 사용됩니다.
- 비밀번호 : 보안강화를 위하여 특수문자, 숫자, 영문 중 다양한 조합으로 비밀번호를 만드세요.

- !** ■ 비밀번호 길이 및 제한은 다음과 같습니다.
- 입력 유형에는 대문자, 소문자, 디지털 및 특수기호의 네 가지 유형이 있습니다.
 - 길이 제한 8~13
 - 비밀번호 길이가 8 또는 9 인 경우 최소 3 가지 유형을 포함해야 합니다.
 - 비밀번호 길이가 10보다 크거나 같은 경우 2 가지 이상의 유형을 포함해야 합니다.
 - 1234, abcd 와 같은 4 개의 연속 문자를 입력할 수 없습니다.
1111, aaaa 와 같은 4 개의 반복 문자를 입력할 수 없습니다.
- 비밀번호 확인 : 비밀번호 확인을 위해 다시 입력합니다.
 - 코드전송 : 입력한 이메일 주소로 인증 코드를 보냅니다.
 - 이메일 인증 코드 : 이메일로 받은 인증 코드를 입력합니다.

카메라 등록하기

1. 화면 중앙에 있는 추가 ⊕ 버튼을 누르세요.
 - 스마트폰은 인터넷 접속이 가능한 Wi-Fi 네트워크에 연결되어 있어야 합니다.
 - 일부 작업은 앱의 권한이 필요합니다.
- !** ■ 카메라는 1개 계정에서만 등록이 가능하며, 최대 3명까지 동시 접속이 됩니다.

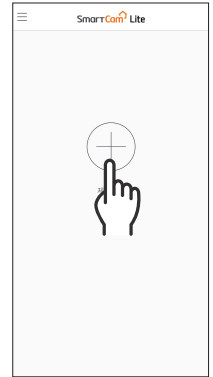

2. 카메라의 QR 코드를 스캔하세요.



3. 전원 어댑터를 카메라에 연결하세요.

- 전원이 연결되면 카메라의 LED 표시등이 빨간색으로 표시되고 약 1분 이내에 깜빡거리기 시작합니다.

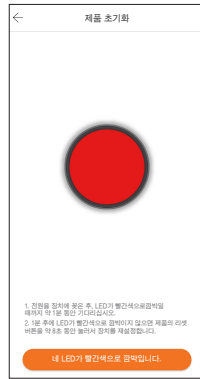

4. 스마트폰에 연결된 Wi-Fi 네트워크 정보가 표시되면 Wi-Fi 비밀번호를 입력하고 <다음>을 누르세요.



- Wi-Fi 공유기의 비밀번호 (알파벳 대문자 구분)가 정확하지 않으면 다음 진행 단계에서 등록이 되지 않으니 주의하세요.
- 공유기 비밀번호가 틀려 카메라 등록이 실패하면 카메라 LED는 파란색 점멸과 노란색 점등을 반복합니다. 이럴 경우 카메라 RESET 버튼을 8초간 눌러 초기화시킨 후에 재시도 바랍니다.
- 5 GHz 주파수 대역의 Wi-Fi는 지원하지 않습니다. 스마트폰을 반드시 2.4 GHz 주파수 대역의 Wi-Fi 네트워크에 연결하세요.
- WPA Enterprise 인증 방식은 지원하지 않습니다. 공유기 웹 페이지에 접속하거나, 가입한 통신사에 문의하면 공유기 인증 방식을 확인할 수 있습니다.

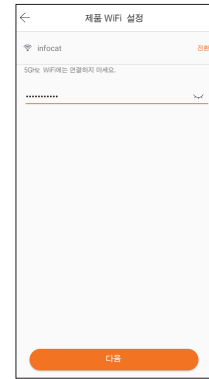

- 카메라 설치 장소가 바뀌어 새로운 Wi-Fi 네트워크 연결이 필요한 경우 카메라 전원을 연결하면 LED는 부팅 후 파란 색으로 깜빡이다가 노란 색이 됩니다. 카메라의 초기화 버튼을 3초 동안 눌러 LED가 빨간 색으로 변경되면 홈 목록에서 카메라를 삭제한 후에 카메라 등록 단계를 다시 진행해 주세요. Wi-Fi 설정을 제외한 모든 설정은 그대로 유지됩니다.

※ 일부 iOS 스마트폰은 Wi-Fi 정보를 얻기 위해 권한 승인이 필요합니다. 아래 안내에 따라 진행하세요.

- 1) <설정>을 누르고 iOS 애플리케이션 권한 설정으로 진입하세요.
- 2) <위치>를 누르세요.
- 3) <앱을 사용하는 동안>으로 권한을 설정하세요.

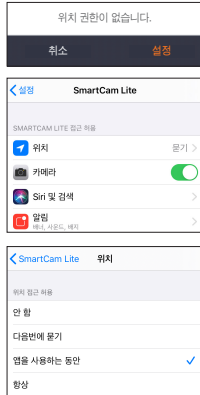

5. 화면의 QR 코드를 카메라의 렌즈와 평행하게 유지한 채로 15 ~ 30 cm 거리를 두고, 앞/뒤로 이동하거나 각도를 조금씩 변경하세요.

- 스마트폰 화면을 밝게 한 후, 생성된 QR 코드의 중앙부분에 맞춰 카메라의 렌즈에 향하게 합니다.
- QR 코드 스캔이 완료되면 카메라에서 비프음이 울리고, LED 표시등이 파란색으로 깜빡이면서 Wi-Fi 연결을 시도합니다.
- Wi-Fi 연결이 성공하면 LED 표시등이 깜빡임을 멈추고 파란색으로 계속 유지됩니다.
- 스마트폰 화면에서 <네, LED가 파란색으로 이미 바뀌었습니다.>를 누르고 7번 설명으로 넘어가세요.
- Wi-Fi 연결을 위한 스캔 설정이 실패하면 <아니오, LED가 아직 빨간색으로 깜빡이고 있습니다.>를 누르고 6번 설명으로 넘어가세요.



6. <확인>을 누르고 카메라 ID정보가 포함된 네트워크에 연결하세요.

(Android OS 기기 화면)

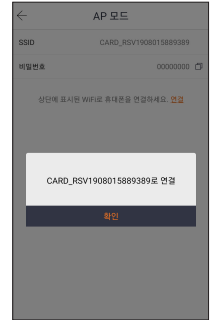

(iOS 기기 화면)

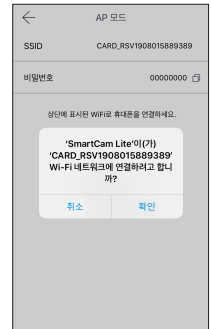

7. 스마트폰과 카메라가 연결될 때까지 기다리세요.

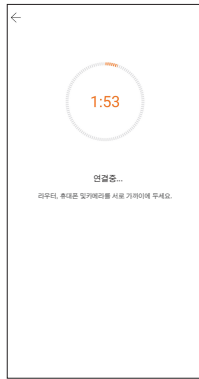

8. 카메라 이름, 비밀번호를 입력한 후 <적용>을 누르세요.

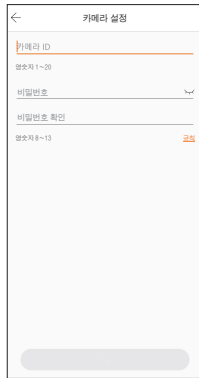

9. 축하합니다!
카메라 등록이 완료되었으며 이제 SmartCam Lite의 실시간 모니터링을 할 수 있습니다.

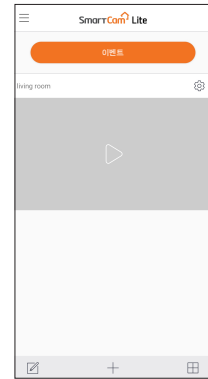

인터페이스 살펴보기

홈 화면



번호	명칭	설명
1	메뉴	홈, 화면설정, 파일공유, 도움말, 정보를 확인합니다.
2	이벤트	이벤트 영상을 확인합니다.
3	라이브	실시간 모니터링 화면으로 넘어갑니다.
4	카메라 삭제	등록된 카메라를 삭제합니다
5	카메라 등록	새로운 카메라를 추가 등록합니다.
6	카메라 정렬	등록된 카메라를 리스트나 그리드 형태로 정렬합니다.
7	카메라 설정	카메라 기능을 설정합니다.

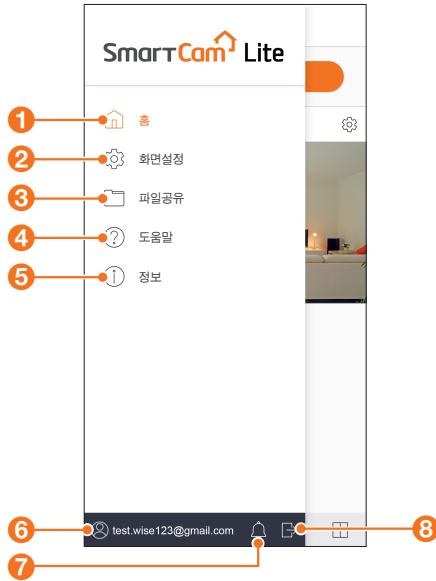

번호	명칭	설명
1	홈	홈 화면으로 돌아갑니다.
2	화면설정	SmartCam Lite 앱 설정 화면으로 이동합니다.
3	파일공유	라이브 화면에서 직접 캡처한 이미지나 녹화한 동영상상을 보거나 공유할 수 있습니다.
4	도움말	도움말 페이지를 열어 자주 묻는 질문 등을 확인할 수 있습니다.
5	정보	앱 정보를 확인합니다.
6	계정편집	사용자 정보 변경 화면으로 이동하여 비밀번호를 변경하거나 회원 탈퇴를 할 수 있습니다.
7	이벤트 알림	앱의 알림 기능을 켜거나 끕니다.
8	나가기	현재 로그인된 계정을 로그아웃합니다.

이벤트

홈 화면에서 <이벤트>를 누르고 원하는 이벤트 타입을 선택하여 카메라의 SD카드에 저장된 이벤트 영상들을 확인할 수 있습니다.

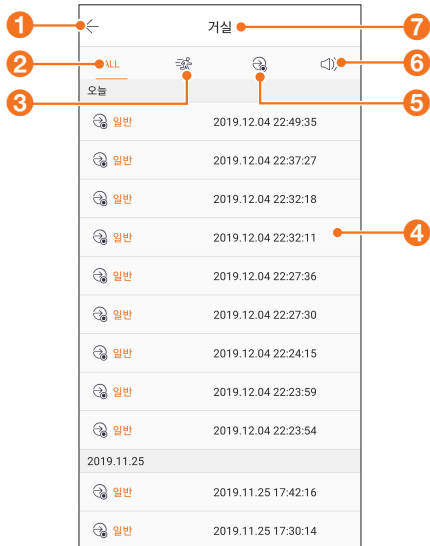

번호	명칭	설명
1	이전	이전 화면으로 돌아가합니다.
2	All	카메라의 SD카드에 저장된 모든 녹화 목록을 보여줍니다.
3	움직임감지 이벤트	움직임 감지 이벤트로 발생한 녹화 목록을 보여줍니다.
4	이벤트 목록	선택된 이벤트 타입에 따라 목록이 나타나며, 이벤트 기록을 누르면 녹화된 영상의 재생화면으로 넘어갑니다.
5	일반 녹화	스케줄 저장 설정에 따라 녹화된 일반 목록 (연속 녹화)을 보여줍니다.
6	오디오 감지 이벤트	오디오 감지 이벤트로 발생한 녹화 목록을 보여줍니다.
7	카메라 이름	현재 연결된 카메라의 이름을 표시합니다.

화면 모니터링하기

실시간 모니터링 화면

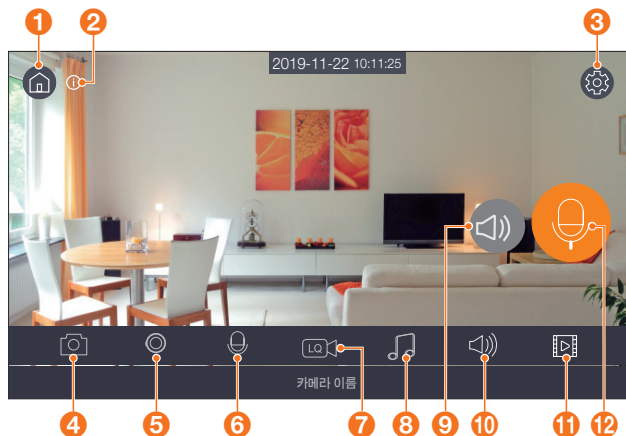

번호	표시	명칭	설명
1		홈	실시간 모니터링을 종료하고 홈 화면으로 돌아갑니다.
2		정보	아이콘 기능에 대한 설명을 제공합니다.
3		카메라 설정	카메라 기능을 설정합니다.
4		캡처	현재 영상을 캡처하여 저장하거나 공유할 수 있습니다.

5		저장	실시간 모니터링 영상을 녹화하여 스마트폰에 저장합니다.
6		말하기	카메라와 스마트폰 간의 양방향 대화를 위한 마이크가 활성화 됩니다.
7		해상도	현재 연결된 영상의 화질을 나타냅니다. 다른 화질로 변경하려면 누르세요.
8		알람 사운드	카메라의 알람 종류를 선택하세요. (경찰차 사이렌, 알람 사이렌, 개 짖는 소리 제공)
9		스피커/마이크 조절	카메라의 마이크 및 스피커 음량을 조정합니다. *말하기 기능 사용 시 표시됩니다.
10		소리	모니터링 중인 영상 주변의 소리를 켜거나 끕니다.
11		재생	재생 화면으로 전환합니다.
12		마이크	아이콘을 누른 상태에서 이야기하면 카메라의 스피커로 출력됩니다. *말하기 기능 사용 시 표시됩니다.

재생 화면

실시간 모니터링 화면에서 <재생 ▶> 버튼을 누르면 재생화면으로 이동합니다.

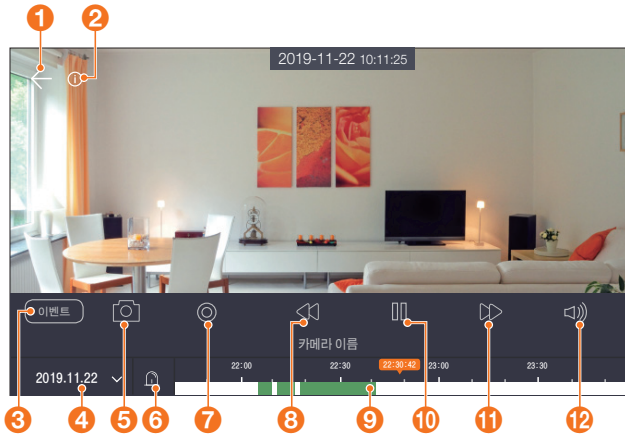

번호	표시	명칭	설명
1	←	이전	실시간 모니터링 화면으로 이동합니다.
2	i	정보	재생 화면의 각 기능에 대한 정보를 확인할 수 있습니다.
3	이벤트	이벤트	이벤트 목록을 텍스트나 썸네일로 볼 수 있습니다.
4	2019.11.22 ∨	녹화일 검색	캘린더를 열어 날짜 별로 영상을 검색합니다. - 녹화영상이 있는 날은 날짜 아래 빨간색 점이 표시됩니다.
5	📷	캡처	현재 재생 중인 영상을 캡처하여 스마트폰에 저장합니다.
6	🔒	이벤트 선택	이벤트 타입 별로 영상을 검색합니다.
7	📌	저장	현재 재생 중인 영상을 녹화하여 스마트폰에 저장합니다.
8	🔊	느린 재생	재생 속도를 1/2, 1/4, 1/8, 1/16 속도로 느리게 재생합니다.
9	📊	타임라인	원하는 재생 지점으로 드래그하여 영상을 빠르게 검색합니다.
10	⏸	재생/일시정지	영상을 재생하거나 일시정지시킵니다.
11	⏩	빠른 재생	재생 속도를 2배, 4배, 8배, 16배 속도로 빠르게 재생합니다.
12	🔇	소리	재생 중인 영상의 소리를 켜거나 끕니다.

카메라 설정

04

카메라 설정하기

- 카메라 설정 메뉴 24
- 일반 설정 25
- 영상 설정 26
- 이벤트 설정 27
- 움직임 감지 28
- 오디오 감지 29
- Wi-Fi 설정 29
- 저장 30
- 알림 31

카메라 설정하기

홈 화면 또는 실시간 모니터링 화면에서 <카메라 설정> 버튼을 누르면 현재 연결된 카메라에 관련된 다양한 설정을 할 수 있습니다.

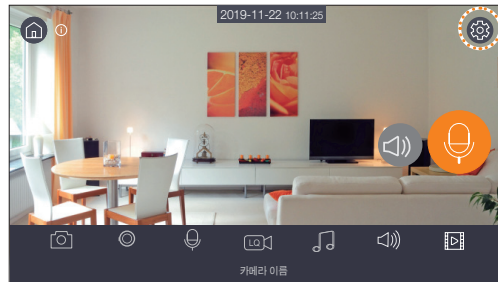
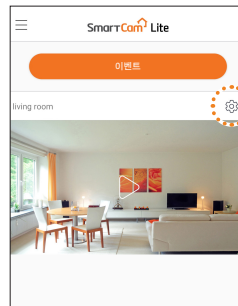

카메라 설정 메뉴

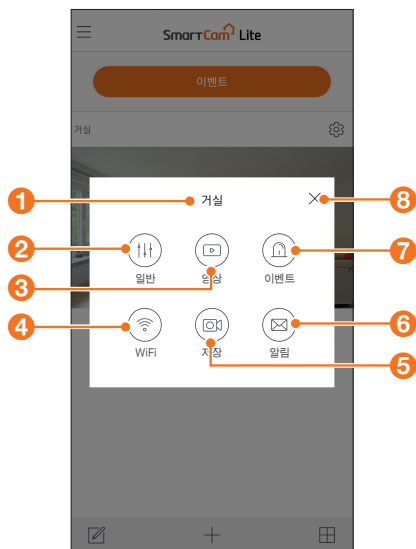

번호	명칭	설명
1	카메라 이름	현재 연결된 카메라의 이름을 표시합니다.
2	일반	카메라 이름 수정, 비밀번호 변경, 시간대 설정, 썸머 타임 설정, LED 상태 설정, 카메라 초기화, 등록된 카메라 삭제 등을 실행할 수 있습니다. 현재 펌웨어와 신규 펌웨어 버전을 비교해 업데이트합니다.
3	영상	영상 화면과 음량 상태, 나이트 비전(야간조명) 모드를 설정합니다.
4	WiFi	카메라가 연결된 Wi-Fi네트워크를 변경합니다.
5	저장	카메라에 삽입한 SD 카드 상태와 스케줄 저장을 설정합니다.
6	알림	스마트폰 알림 및 이메일 알림, 알림 스케줄을 설정합니다.
7	이벤트	움직임 감지와 오디오 감지 모드를 설정합니다.
8	닫기	카메라 설정 메뉴를 닫습니다. (팝업 창 밖의 다른 부분을 눌러도 메뉴를 닫을 수 있습니다.)

일반 설정

홈 화면 또는 실시간 모니터링 화면에서 <카메라 설정 > 버튼을 눌러 팝업 메뉴가 나타나면 <일반>을 누르세요.



번호	명칭	설명
1	이전	이전 메뉴로 되돌아갑니다.
2	카메라 이름	카메라의 이름을 변경합니다.

3	비밀번호 변경	카메라 연결에 필요한 비밀번호를 변경합니다.
4	시간	카메라에 설정된 현재 시간을 표시합니다.
5	시간대	현재 지역에 맞는 시간대를 설정합니다.
6	썸머타임	썸머타임 적용 여부를 선택합니다. *썸머타임 설정 시 시간이 1시간 앞당겨지니 유의하시기 바랍니다.
7	LED 상태	LED 표시등을 켜거나 끕니다.
8	펌웨어 버전	카메라 펌웨어의 현재 버전을 표시합니다. - 신규 버전 (빨간색 점 표시)이 있으면 펌웨어를 업데이트할 수 있습니다. *카메라가 Wi-Fi 공유기와 멀거나 Wi-Fi 신호 세기가 약할 경우 펌웨어 다운로드를 완료하지 못할 수 있으며, (보라색 점등 상태) 이후 카메라는 6분 후에 현재 펌웨어로 루팅되어 정상 동작됩니다. 이럴 경우 카메라를 공유기 근처로 옮겨 와서 펌웨어 업데이트를 실행해 주세요.
9	카메라 초기화	네트워크 설정을 제외한 카메라의 모든 설정을 초기화합니다.
10	카메라 삭제	현재 등록된 카메라를 삭제합니다. - 등록된 카메라를 삭제할 경우 5분 (서버 처리 시간) 이후에 삭제가 가능합니다.
11	적용	변경된 설정 값을 저장합니다. 변경된 설정이 없을 경우 버튼이 비활성화 됩니다.



- 카메라 설치 장소가 바뀌어 새로운 Wi-Fi 네트워크 연결이 필요한 경우 카메라 전원을 연결하면 LED는 부팅 후 파란 색으로 깜박이다가 노란 색이 됩니다. 카메라의 초기화 버튼을 3초 동안 눌러 LED가 빨간 색으로 변경되면 홈 목록에서 카메라를 삭제한 후에 카메라 등록 단계를 다시 진행해 주세요. Wi-Fi 설정을 제외한 모든 설정은 그대로 유지됩니다.

영상 설정

홈 화면 또는 실시간 모니터링 화면에서 <카메라 설정 > 버튼을 눌러 팝업 메뉴가 나타나면 <영상>을 누르세요.



번호	명칭	설명
1	이전	이전 메뉴로 되돌아갑니다.
2	OSD 시간	기본 설정은 활성화되어 있으며 현재 시간을 영상 화면 상단에 표시합니다.
3	나이트 비전 켜기/끄기	기본 설정은 활성화되어 있으며 어두운 환경에서 흑백으로 전환되며 자동으로 IR 조명이 동작합니다. 비활성화 시 나이트 비전 모드로 전환되지 않으며 컬러로만 동작합니다.
4	밝기	현재 영상의 밝기를 조절합니다.
5	영상 회전	영상 이미지를 상하/좌우로 변경할 수 있습니다.
6	음량	카메라의 내장 마이크 및 스피커의 볼륨을 조절합니다. 이 설정은 모바일 기기 자체의 출력을 조절하지는 않습니다. 단, 음량을 높이더라도 모바일 기기의 소리 출력이 0으로 되어 있다면 소리가 들리지 않습니다.
7	WDR	이 기능을 실행하면 어두운 곳은 밝게, 밝은 곳은 어둡게 역광을 보정합니다.

이벤트 설정

홈 화면 또는 실시간 모니터링 화면에서 <카메라 설정 > 버튼을 눌러 팝업 메뉴가 나타나면 <이벤트>를 누르세요.

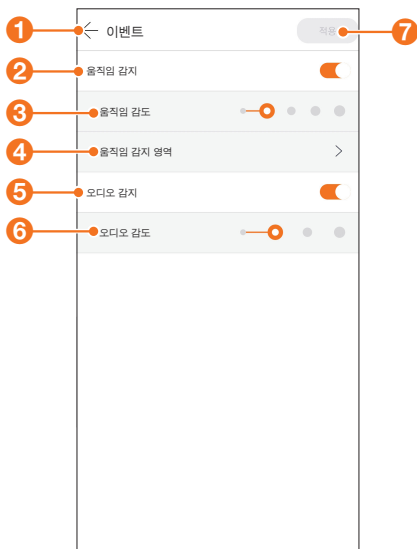

번호	명칭	설명
1	이전	이전 메뉴로 되돌아갑니다.
2	움직임 감지	움직임 감지 기능 사용 여부를 선택합니다. 토글 스위치를 활성화하면 움직임 감도를 조절하거나 원하는 영역 내에서만 알람을 발생하는 움직임 감지 영역 설정이 가능합니다.
3	움직임 감도	감도는 5단계로 설정이 가능합니다. 감도가 높을수록 미세한 움직임까지 감지합니다. 불필요한 움직임 감지 이벤트 발생을 줄이려면 감도를 낮추세요.
4	움직임 감지 영역	실시간 모니터링 화면에서 관심 영역을 드래그하여 박스 형태로 드래그하여 감지 영역을 설정합니다. 자세한 내용은 '움직임 감지 영역 설정'을 참조하세요.
5	오디오 감지	오디오 감지 기능 사용 여부를 선택합니다. 토글 스위치를 활성화하면 오디오 감도 조절이 가능합니다.
6	오디오 감도	감도는 4단계로 설정이 가능합니다. 감도가 높을수록 미세한 소리까지 감지합니다. 과다한 오디오 감지 이벤트 발생을 줄이려면 감도를 낮추세요.
7	적용	변경된 설정 값을 저장합니다. - 변경된 설정이 없을 경우 버튼이 비활성화 됩니다.



- 이벤트 설정은 기능 적용 여부만 설정이 가능합니다.
이벤트 발생 시 녹화를 하거나 스마트폰 또는 이메일로 알림 메시지를 받으려면 <카메라 설정 > → <저장 > 및 <카메라 설정 > → <알림 >에서 설정하세요.

움직임 감지

움직임이 감지되면 스케줄 저장 설정에 따라 영상을 녹화하거나 알림 설정에 따라 알림 메시지를 보냅니다.

1. <카메라 설정 > > <이벤트 > 를 누르세요.
2. 토글 스위치를 눌러 움직임 감지 기능을 활성화 하세요.
3. 움직임 감도를 조절하세요.

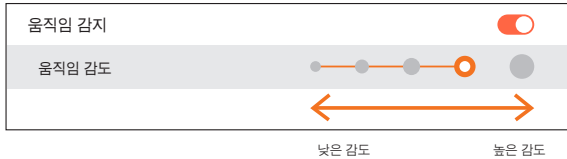

- 감도가 높을수록 미세한 움직임까지 감지합니다.
- 불필요한 움직임 감지 이벤트 발생을 줄이려면 감도를 낮추세요.

❖ 움직임 감지 영역 설정

1. <카메라 설정 > > <이벤트 > 를 누르세요.
2. 토글 스위치를 눌러 움직임 감지 기능을 활성화 하세요.
3. <움직임 감지 영역>을 누르세요.
4. <전체삭제>를 눌러 영역 설정을 초기화 하세요.
5. 실시간 모니터링 화면에서 관심 영역을 드래그하여 박스를 그려주세요.
 - 최대 3개까지 움직임 영역 설정이 가능합니다.
6. <적용>을 누르세요.

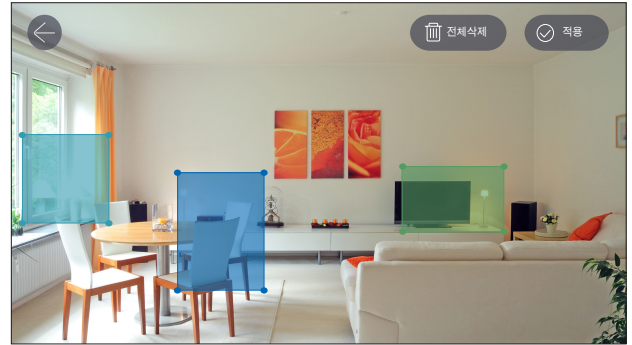

- 최초 실행 시 전체 화면이 움직임 감지 영역으로 설정되어 있습니다.
- 원하는 위치에 움직임 감지 영역 (최대 3개)을 설정하시고 사용해 주세요.

오디오 감지

오디오가 감지되면 스케줄 저장 설정에 따라 영상을 녹화하거나 알림 설정에 따라 알람 메시지를 보냅니다.

1. <카메라 설정 > > <이벤트 > 를 누르세요.
2. 토글 스위치를 눌러 오디오 감지 기능을 활성화 하세요.
3. 오디오 감도를 조절하세요.
4. 설정을 저장하려면 <적용> 을 누르세요.

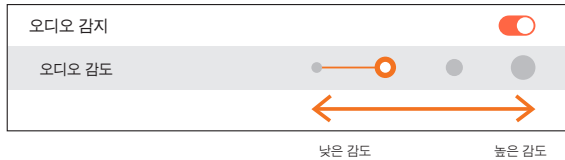

- 감도가 높을수록 미세한 소리까지 감지합니다.
- 과도한 오디오 감지 이벤트 발생을 줄이려면 감도를 낮추세요.

Wi-Fi 설정

홈 화면 또는 실시간 모니터링 화면에서 <카메라 설정 > 버튼을 눌러 팝업 메뉴가 나타나면 <WiFi> 를 누르세요.



번호	명칭	설명
1	이전	이전 메뉴로 되돌아갑니다.
2	새로고침	카메라 주변의 Wi-Fi 네트워크를 다시 검색합니다.
3	현재 연결된 Wi-Fi 네트워크	현재 카메라가 연결된 Wi-Fi 네트워크 이름 앞에는 빨간색 점이 표시됩니다.
4	연결 가능한 Wi-Fi 네트워크 목록	현재 연결 가능한 Wi-Fi 네트워크를 목록으로 보여줍니다. 다른 Wi-Fi 네트워크로 변경할 때 Wi-Fi 네트워크의 비밀번호를 틀리게 입력하면 카메라의 리셋 버튼을 눌러 초기화해야만 재연결이 가능합니다.

저장

기본 화면 또는 실시간 모니터링 화면에서 <카메라 설정 > 버튼을 눌러 팝업 메뉴가 나타나면 <저장>을 누르세요.

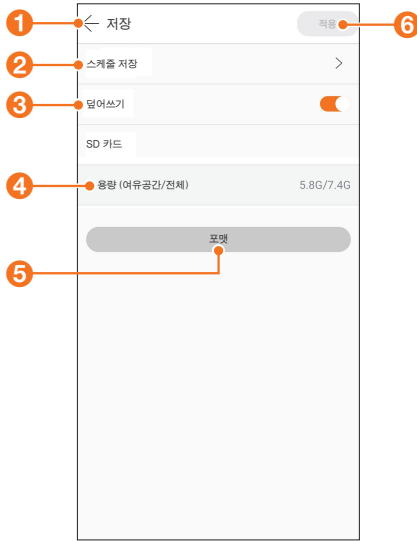

번호	명칭	설명
1	이전	이전 메뉴로 되돌아갑니다.
2	스케줄 저장	각 이벤트 별 녹화 스케줄을 요일별로 설정할 수 있습니다.
3	덮어쓰기	이 기능은 기본 설정으로 활성화되어 있습니다. SD 카드의 용량이 부족하면 가장 오래된 영상부터 자동으로 덮어쓰기 합니다. 덮어쓰기 기능을 해제한 상태에서 SD 카드 여유 공간이 10% 미만이 되면 스마트 폰으로 푸시 알림을 보냅니다.
4	용량 (여유공간/전체)	SD 카드의 사용 가능한 용량 / 총용량을 표시합니다. SD 카드를 장착하고 여유공간이 0M/14.7G (예)로 표시되면 포맷하고 사용바랍니다. 메모리의 일부가 시스템에 할당되므로 포맷을 하면 총용량보다 사용 가능한 용량이 더 작게 표시됩니다. SD 카드를 포맷하면 file0, file1,,, 형태로 용량을 분할해 저장할 공간을 만듭니다.
5	포맷	SD 카드를 포맷합니다. SD 카드 용량이 비정상 상태로 표시되거나 이벤트 저장이 되지 않으면 SD카드 영상을 다른 저장매체로 백업한 후에 포맷하고 사용 바랍니다.
6	적용	변경된 설정 값을 저장합니다. - 변경된 설정이 없을 경우 버튼이 비활성화 됩니다.

- ! SD 카드는 영상이 손상되거나 SD 카드가 고장이 날 수 있으니 카메라 전원을 끈 상태에서 탈착해주시기 바랍니다.
또한, 다른 IT 기기에서 사용하던 SD 카드를 카메라에 장착하면 데이터가 삭제될 수 있으니 주의하시기 바라며 SD 카드는 앱에서 포맷하고 사용하시기 바랍니다.

※ 권장 SD카드

제조사: Sandisk, Transcend

사 양: 최소 Class 6 이상, MLC 방식 이상, 최대 128GB 지원,
FAT32 파일시스템 지원

❖ 스케줄 저장

1. <카메라 설정 > → <저장 > → <스케줄 저장>을 누르세요.
2. 이벤트 타입을 눌러 설정하려는 타입을 선택하세요.
 - 예를 들어, 이벤트 타입을 <움직임>으로 선택하면 움직임 감지 설정 값들이 표시됩니다.
3. 원하는 요일의 시간대를 누르거나 위 아래로 드래그 하여 스케줄을 설정하세요.
4. <적용>을 누른 후 성공 메시지가 나타나면 <확인>을 누르세요.



❖ SD 카드에 저장된 영상 확인하기

SD카드에 저장된 영상을 PC에서 보려면 당사 홈페이지 (wisenetlife.com)에서 제공하는 SCL-VIDEO Player (전용 뷰어)를 사용해야 합니다.

파일 이름 index0 에서 [열기]를 누르면 저장 영상이 있는 날짜가 표시됩니다.

원하는 영상을 선택해 다운로드하면 PC에 mp4 파일 형태로 저장됩니다.

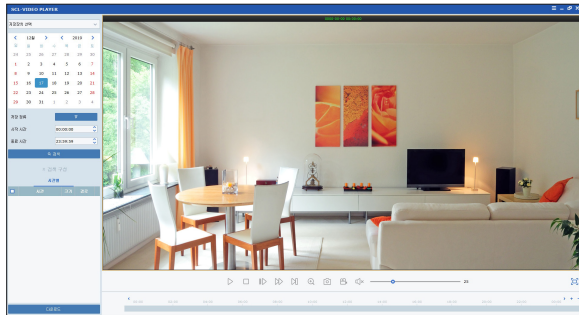

알림

홈 화면 또는 실시간 모니터링 화면에서 <카메라 설정 > 버튼을 눌러 팝업 메뉴가 나타나면 <알림>을 누르세요.



번호	명칭	설명
1	이전	이전 메뉴로 되돌아갑니다.
2	스마트폰 알림	스마트폰 알림 기능 사용 여부를 선택합니다. 알림 스케줄이 설정된 시간에 이벤트가 발생하면 스마트폰으로 알림 메시지를 보냅니다. 이 기능을 사용하려면 모바일 기기가 구글 푸시(Google Push)를 지원해야 합니다.
3	이메일 알림	이벤트가 발생하면 알림 메시지를 보내고 받을 수 있는 이메일 주소를 설정합니다.
4	알림 스케줄	스마트폰 알림 및 이메일 알림 기능이 작동할 스케줄을 설정합니다.

❖ 스마트폰 알림

구글 푸시(Google Push)를 지원하는 스마트폰인 경우 카메라에서 이벤트가 발생하면 스마트폰으로 알림 메시지를 보냅니다.

1. <카메라 설정 > ➡ <알림 >을 누르세요.
2. 토글 스위치를 눌러 스마트폰 알림 기능을 활성화 하세요.
 - 구글 푸시(Google Push)를 지원하는 기기만 이 기능을 사용할 수 있습니다.
3. <알림 스케줄>을 누르세요.
4. 이벤트 타입을 눌러 설정하려는 타입을 선택하세요.
 - 예를 들어, 이벤트 타입을 <움직임>으로 선택하면 움직임 감지 설정 값들이 표시됩니다.
5. 원하는 요일의 시간대를 누르거나 위 아래로 드래그 하여 스케줄을 설정하세요.
6. <적용>을 누른 후 성공 메시지가 나타나면 <확인>을 누르세요.



❖ 이메일 알림

이벤트 발생 시 알림 메시지를 받을 수 있는 이메일을 설정합니다.

1. <카메라 설정 > ➡ <알림 > ➡ <이메일 알림>을 누르세요.
2. 토글 스위치를 눌러 이메일 설정이 가능하도록 활성화 하세요.
3. 알림 메시지를 보낼 수신자의 이메일을 등록하세요.
 - 구글 메일(GMail)만 메일 보내기가 가능합니다.
4. 알림 메시지를 받을 이메일을 등록하세요.
 - 수신자 이메일은 최대 3개까지 등록할 수 있습니다.
5. <적용>을 누른 후 성공 메시지가 나타나면 <확인>을 누르세요.
6. <알림 스케줄>을 누르세요.
7. 이벤트 타입을 눌러 설정하려는 타입을 선택하세요.
 - 예를 들어, 이벤트 타입을 <움직임>으로 선택하면 움직임 감지 설정 값들이 표시됩니다.
8. 원하는 요일의 시간대를 누르거나 위 아래로 드래그 하여 스케줄을 설정하세요.
9. <적용>을 누른 후 성공 메시지가 나타나면 <확인>을 누르세요.

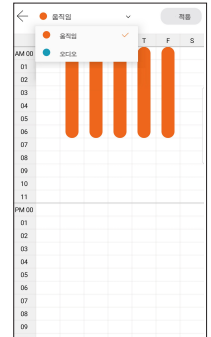
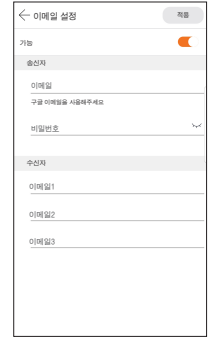

제품 사양

사양
제품 외관 (카메라)

33

33

34

문제해결

35

OPEN SOURCE ANNOUNCEMENT

36

제품 사양

사양

명칭	설명
운영체제	Linux
해상도	1920x1080, 640x480
최대 프레임레이트	1920x1080 30FPS
비디오 압축 방식	H.264
동시 전송 능력	멀티 스트림 전송
화각 (대각/수직/수평)	110° / 48.8° / 90.8°
저조도	0.3 Lux (컬러), 0 Lux (흑백)
WDR	DWDR
Day & Night	True D/N (Auto)
나이트 비전	IR LED, 8M
디지털줌	4x(Mobile)
영상 회전	지원
움직임 감지	지원
오디오 감지	지원
오디오 I/O	내장 마이크와 스피커
오디오 압축 방식	AAC

명칭	설명
오디오 통신	2-Way Audio (Built-in Microphone & Speaker), Half Duplex
메모리 슬롯	SDXC 메모리 슬롯 (최대 128GB)
저장 및 재생	이벤트 녹화, 수동 녹화, 연속 녹화, 원격 재생
무선	Wi-Fi 802.11 b/g/n (Single-band)
보안	HTTPS(SSL) 인증 방식 다이제스트 인증 방식
최대 사용자 수	3명 (유니캐스트 모드)
동작 온/습도	DC 5V, 0°C ~ 40°C (+32°F ~ +104°F) / 90% RH 이하
IP 등급	-
사용전원/소비전류	5 V/1 A
소비 전력	최대 3.7 W
상태 표시	1 LED (전원, 상태, 링크)
색상	흰색
외형 치수 (ØxH)	Ø 75.4 x 101.5 mm
무게	205 g

제품 외관 (카메라)

단위: mm (인치)

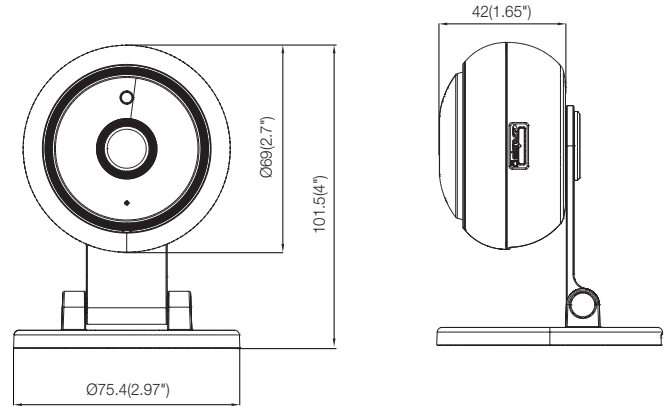

문제해결

시스템에 문제가 발생할 경우 아래 표를 참고하여 최대한 신속하게 문제를 해결하세요. 아래 지침에 따르세요.

문제	조치
계정 비밀번호를 잊어버렸습니다.	<ul style="list-style-type: none"> - 로그인 화면에서 <비밀번호 찾기>를 누른 후 등록된 이메일 주소로 입력하면 새로운 비밀번호를 이메일 주소로 보내드립니다. 이메일 서버 설정에 따라 스팸 메일로 처리될 수도 있습니다. 로그인하면 제공된 임시 비밀번호를 변경할 것을 권장합니다.
카메라와 무선 공유기가 연결되지 않습니다.	<ul style="list-style-type: none"> - 카메라의 LED 표시등이 자주 변경되는 경우 카메라 설치 장소의 Wi-Fi 신호가 양호하지 않을 수 있으니, 무선 공유기에 카메라를 더 가깝게 배치한 후 연결을 다시 시도합니다. - 카메라 등록 시 입력한 Wi-Fi 비밀번호를 확인 후 다시 시도합니다.
로그인한 후에 카메라를 등록할 수 없습니다.	<ul style="list-style-type: none"> - 앱의 홈 화면을 아래로 내려 등록하려는 카메라가 있는지 확인합니다. 원하는 카메라가 없을 경우 '카메라 등록하기'를 참조하세요. (12쪽) - 만약 위와 같은 조치에도 불구하고 카메라가 등록 되지 않으면 카메라를 공장 초기화하여 처음부터 다시 시작합니다. (공장 초기화를 하려면 카메라에 있는 초기화 버튼을 8초 동안 눌러주세요. 출하 시 설정으로 초기화되면 카메라가 다시 시작됩니다.)
라이브 연결이 안되거나 불안정합니다.	<ul style="list-style-type: none"> - 카메라와 공유기 사이에 장애물 (금속, 벽 등)이 있을 경우, 무선 특성 상 카메라가 받는 신호 강도가 떨어집니다. 이럴 경우 Wi-Fi 증폭기 (Extender)를 연결해 사용 거리를 넓혀 주세요. - 주변의 WiFi 공유기로 인해 신호 간섭을 받을 경우에도 카메라의 신호 강도가 떨어집니다. 이럴 경우 연결할 공유기의 WiFi 채널을 간섭이 없는 채널로 변경해야 합니다. - 고객 서비스 센터에 문의바랍니다.

문제	조치
카메라의 영상이 일시적으로 사라집니다.	<ul style="list-style-type: none"> - 네트워크 지연으로 인해 카메라 영상이 지연될 수도 있습니다. 카메라를 Wi-Fi 신호가 양호한 곳에 설치했는지 확인하세요.
동영상에서 소리가 나지 않습니다.	<ul style="list-style-type: none"> - 영상 재생 화면에서 소리 아이콘을 클릭하거나 스마트폰 앱에서 볼륨이 켜져 있는지 확인하세요.
카메라 비밀번호를 잊어버렸습니다.	<ul style="list-style-type: none"> - 새로운 카메라 비밀번호를 생성해야 합니다. - 카메라의 초기화 버튼을 8초 이상 눌러 공장초기화 합니다. - 공장 초기화 후 카메라를 등록하여 카메라 비밀번호를 재설정 할 수 있습니다.
계정 비밀번호를 변경하고 싶습니다.	<ul style="list-style-type: none"> - 홈화면의 메뉴에 있는 <계정편집>이나 <카메라 설정 > → <일반> 메뉴에서 신규 비밀번호를 설정할 수 있습니다.
알림 이메일이 수신되지 않습니다.	<ul style="list-style-type: none"> - 구글 정책상 이메일 수신이 안될 경우 구글 웹페이지 계정 - 보안 메뉴에서 "보안 수준이 낮은 앱의 액세스" 기능을 허용해 주세요. 카메라 감지 이벤트를 이메일로 받을 때만 해당되며, 카메라 자체 보안 기능과는 무관합니다.

OPEN SOURCE ANNOUNCEMENT

Some software components of this product incorporate source code covered under the BSD license as follows.

Component Name	License	License URL
lighttpd 1.4.25	BSD 2.0	http://www.opensource.org/licenses/bsd-license.html
librtmp 1.20	BSD 1.0	
net-snmp-5.4	BSD	http://www.net-snmp.org/about/license.html

lighttpd is a secure, fast, compliant, and very flexible web-server that has been optimized for high-performance environments. It has a very low memory footprint compared to other web servers and takes care of cpu-load. Its advanced feature-set (FastCGI, CGI, Auth, Output-Compression, URL-Rewriting and many more) make lighttpd the perfect webserver-software for every server that suffers load problems.

Simple Network Management Protocol (SNMP) is an Internet standard protocol for managing devices on IP networks. It is used mostly in network management systems to monitor the devices attached to the network for conditions that need administrative attention. Net-SNMP is a suite of applications used to implement SNMP v1, SNMP v2c and SNMP v3 using both IPv4 and IPv6.

For more additional information, send email to help.cctv@samsung.com.

Copyright (C) 1989, 1991 Free Software Foundation, Inc.

All rights reserved.

Redistribution and use in source and binary forms, with or without modification, are permitted provided that the following conditions are met :

- Redistributions of source code must retain the above copyright notice, this list of conditions and the following disclaimer.
- Redistributions in binary form must reproduce the above copyright notice, this list of conditions and the following disclaimer in the documentation and/or other materials provided with the distribution.
- Neither the name of the 'incremental' nor the names of its contributors may be used to endorse or promote products derived from this software without specific prior written permission.

THIS SOFTWARE IS PROVIDED BY THE COPYRIGHT HOLDERS AND CONTRIBUTORS "AS IS" AND ANY EXPRESS OR IMPLIED WARRANTIES, INCLUDING, BUT NOT LIMITED TO, THE IMPLIED WARRANTIES OF MERCHANTABILITY AND FITNESS FOR A PARTICULAR

PURPOSE ARE DISCLAIMED. IN NO EVENT SHALL THE COPYRIGHT OWNER OR CONTRIBUTORS BE LIABLE FOR ANY DIRECT, INDIRECT, INCIDENTAL, SPECIAL, EXEMPLARY, OR CONSEQUENTIAL DAMAGES (INCLUDING, BUT NOT LIMITED TO, PROCUREMENT OF SUBSTITUTE GOODS OR SERVICES; LOSS OF USE, DATA, OR PROFITS; OR BUSINESS INTERRUPTION) HOWEVER CAUSED AND ON ANY THEORY OF LIABILITY, WHETHER IN CONTRACT, STRICT LIABILITY, OR TORT (INCLUDING NEGLIGENCE OR OTHERWISE) ARISING IN ANY WAY OUT OF THE USE OF THIS SOFTWARE, EVEN IF ADVISED OF THE POSSIBILITY OF SUCH DAMAGE.

Copyright (c) 1998-2001 University College London

All rights reserved.

Redistribution and use in source and binary forms, with or without modification, is permitted provided that the following conditions are met :

1. Redistributions of source code must retain the above copyright notice, this list of conditions and the following disclaimer.
2. Redistributions in binary form must reproduce the above copyright notice, this list of conditions and the following disclaimer in the documentation and/or other materials provided with the distribution.
3. All advertising materials mentioning features or use of this software must display the following acknowledgement: This product includes software developed by the Computer Science Department at University College London.
4. Neither the name of the University nor of the Department may be used to endorse or promote products derived from this software without specific prior written permission.

THIS SOFTWARE IS PROVIDED BY THE AUTHORS AND CONTRIBUTORS "AS IS" AND ANY EXPRESSED OR IMPLIED WARRANTIES, INCLUDING, BUT NOT LIMITED TO, THE IMPLIED WARRANTIES OF MERCHANTABILITY AND FITNESS FOR A PARTICULAR PURPOSE ARE DISCLAIMED. IN NO EVENT SHALL THE AUTHORS OR CONTRIBUTORS BE LIABLE FOR ANY DIRECT, INDIRECT, INCIDENTAL, SPECIAL, EXEMPLARY, OR CONSEQUENTIAL DAMAGES (INCLUDING, BUT NOT LIMITED TO, PROCUREMENT OF SUBSTITUTE GOODS OR SERVICES; LOSS OF USE, DATA, OR PROFITS; OR BUSINESS INTERRUPTION) HOWEVER CAUSED AND ON ANY THEORY OF LIABILITY, WHETHER IN CONTRACT, STRICT LIABILITY, OR TORT (INCLUDING NEGLIGENCE OR OTHERWISE) ARISING IN ANY WAY OUT OF THE USE OF THIS SOFTWARE, EVEN IF ADVISED OF THE POSSIBILITY OF SUCH DAMAGE.

LICENSE

Various copyrights apply to this package, listed in various separate parts below. Please make sure that you read all the parts.

Part 1: CMU/UCD copyright notice: (BSD like)

Copyright 1989, 1991, 1992 by Carnegie Mellon University

Derivative Work - 1996, 1998-2000

Copyright 1996, 1998-2000 The Regents of the University of California

All Rights Reserved

Permission to use, copy, modify and distribute this software and its documentation for any purpose and without fee is hereby granted, provided that the above copyright notice appears in all copies and that both that copyright notice and this permission notice appear in supporting documentation, and that the name of CMU and The Regents of the University of California not be used in advertising or publicity pertaining to distribution of the software without specific written permission.

CMU AND THE REGENTS OF THE UNIVERSITY OF CALIFORNIA DISCLAIM ALL WARRANTIES WITH REGARD TO THIS SOFTWARE, INCLUDING ALL IMPLIED WARRANTIES OF MERCHANTABILITY AND FITNESS. IN NO EVENT SHALL CMU OR THE REGENTS OF THE UNIVERSITY OF CALIFORNIA BE LIABLE FOR ANY SPECIAL, INDIRECT OR CONSEQUENTIAL DAMAGES OR ANY DAMAGES WHATSOEVER RESULTING FROM THE LOSS OF USE, DATA OR PROFITS, WHETHER IN AN ACTION OF CONTRACT, NEGLIGENCE OR OTHER TORTIOUS ACTION, ARISING OUT OF OR IN CONNECTION WITH THE USE OR PERFORMANCE OF THIS SOFTWARE.

Part 2: Networks Associates Technology, Inc copyright notice (BSD)

Copyright (c) 2001-2003, Networks Associates Technology, Inc

All rights reserved.

Redistribution and use in source and binary forms, with or without modification, are permitted provided that the following conditions are met:

- Redistributions of source code must retain the above copyright notice, this list of conditions and the following disclaimer.
- Redistributions in binary form must reproduce the above copyright notice, this list of conditions and the following disclaimer in the documentation and/or other materials provided with the distribution.
- Neither the name of the Networks Associates Technology, Inc nor the names of its contributors may be used to endorse or promote products derived from this software without specific prior written permission.

THIS SOFTWARE IS PROVIDED BY THE COPYRIGHT HOLDERS AND CONTRIBUTORS "AS IS" AND ANY EXPRESS OR IMPLIED WARRANTIES, INCLUDING, BUT NOT LIMITED TO, THE IMPLIED WARRANTIES OF MERCHANTABILITY AND FITNESS FOR A PARTICULAR PURPOSE ARE DISCLAIMED. IN NO EVENT SHALL THE COPYRIGHT HOLDERS OR CONTRIBUTORS BE LIABLE FOR ANY DIRECT, INDIRECT, INCIDENTAL, SPECIAL, EXEMPLARY, OR CONSEQUENTIAL DAMAGES (INCLUDING, BUT NOT LIMITED TO, PROCUREMENT OF SUBSTITUTE GOODS OR SERVICES; LOSS OF USE, DATA, OR PROFITS; OR BUSINESS INTERRUPTION) HOWEVER CAUSED AND ON ANY THEORY OF LIABILITY, WHETHER IN CONTRACT, STRICT LIABILITY, OR TORT (INCLUDING NEGLIGENCE OR OTHERWISE) ARISING IN ANY WAY OUT OF THE USE OF THIS SOFTWARE, EVEN IF ADVISED OF THE POSSIBILITY OF SUCH DAMAGE.

Part 3: Cambridge Broadband Ltd. copyright notice (BSD)

Portions of this code are copyright (c) 2001-2003, Cambridge Broadband Ltd.

All rights reserved.

Redistribution and use in source and binary forms, with or without modification, are permitted provided that the following conditions are met:

- Redistributions of source code must retain the above copyright notice, this list of conditions and the following disclaimer.
- Redistributions in binary form must reproduce the above copyright notice, this list of conditions and the following disclaimer in the documentation and/or other materials provided with the distribution.
- The name of Cambridge Broadband Ltd. may not be used to endorse or promote products derived from this software without specific prior written permission.

THIS SOFTWARE IS PROVIDED BY THE COPYRIGHT HOLDER "AS IS" AND ANY EXPRESS OR IMPLIED WARRANTIES, INCLUDING, BUT NOT LIMITED TO, THE IMPLIED WARRANTIES OF MERCHANTABILITY AND FITNESS FOR A PARTICULAR PURPOSE ARE DISCLAIMED. IN NO EVENT SHALL THE COPYRIGHT HOLDER BE LIABLE FOR ANY DIRECT, INDIRECT, INCIDENTAL, SPECIAL, EXEMPLARY, OR CONSEQUENTIAL DAMAGES (INCLUDING, BUT NOT LIMITED TO, PROCUREMENT OF SUBSTITUTE GOODS OR SERVICES; LOSS OF USE, DATA, OR PROFITS; OR BUSINESS INTERRUPTION) HOWEVER CAUSED AND ON ANY THEORY OF LIABILITY, WHETHER IN CONTRACT, STRICT LIABILITY, OR TORT (INCLUDING NEGLIGENCE OR OTHERWISE) ARISING IN ANY WAY OUT OF THE USE OF THIS SOFTWARE, EVEN IF ADVISED OF THE POSSIBILITY OF SUCH DAMAGE.

Part 4: Sun Microsystems, Inc. copyright notice (BSD)

Copyright © 2003 Sun Microsystems, Inc., 4150 Network

Circle, Santa Clara,

California 95054, U.S.A.

All rights reserved.

Use is subject to license terms below. This distribution may include materials developed by third parties. Sun, Sun Microsystems, the Sun logo and Solaris are trademarks or registered trademarks of Sun Microsystems, Inc. in the U.S. and other countries. Redistribution and use in source and binary forms, with or without modification, are permitted provided that the following conditions are met:

- Redistributions of source code must retain the above copyright notice, this list of conditions and the following disclaimer.
- Redistributions in binary form must reproduce the above copyright notice, this list of conditions and the following disclaimer in the documentation and/or other materials provided with the distribution.
- Neither the name of the Sun Microsystems, Inc. nor the names of its contributors may be used to endorse or promote products derived from this software without specific prior written permission.

THIS SOFTWARE IS PROVIDED BY THE COPYRIGHT HOLDERS AND CONTRIBUTORS "AS IS" AND ANY EXPRESS OR IMPLIED WARRANTIES, INCLUDING, BUT NOT LIMITED TO,



THE IMPLIED WARRANTIES OF MERCHANTABILITY AND FITNESS FOR A PARTICULAR PURPOSE ARE DISCLAIMED. IN NO EVENT SHALL THE COPYRIGHT HOLDERS OR CONTRIBUTORS BE LIABLE FOR ANY DIRECT, INDIRECT, INCIDENTAL, SPECIAL, EXEMPLARY, OR CONSEQUENTIAL DAMAGES (INCLUDING, BUT NOT LIMITED TO, PROCUREMENT OF SUBSTITUTE GOODS OR SERVICES; LOSS OF USE, DATA, OR PROFITS; OR BUSINESS INTERRUPTION) HOWEVER CAUSED AND ON ANY THEORY OF LIABILITY, WHETHER IN CONTRACT, STRICT LIABILITY, OR TORT (INCLUDING NEGLIGENCE OR OTHERWISE) ARISING IN ANY WAY OUT OF THE USE OF THIS SOFTWARE, EVEN IF ADVISED OF THE POSSIBILITY OF SUCH DAMAGE.

Part 5: Sparta, Inc copyright notice (BSD)

Copyright (c) 2003-2009, Sparta, Inc

All rights reserved.

Redistribution and use in source and binary forms, with or without modification, are permitted provided that the following conditions are met:

- Redistributions of source code must retain the above copyright notice, this list of conditions and the following disclaimer.
- Redistributions in binary form must reproduce the above copyright notice, this list of conditions and the following disclaimer in the documentation and/or other materials provided with the distribution.
- Neither the name of Sparta, Inc nor the names of its contributors may be used to endorse or promote products derived from this software without specific prior written permission.

THIS SOFTWARE IS PROVIDED BY THE COPYRIGHT HOLDERS AND CONTRIBUTORS "AS IS" AND ANY EXPRESS OR IMPLIED WARRANTIES, INCLUDING, BUT NOT LIMITED TO, THE IMPLIED WARRANTIES OF MERCHANTABILITY AND FITNESS FOR A PARTICULAR PURPOSE ARE DISCLAIMED. IN NO EVENT SHALL THE COPYRIGHT HOLDERS OR CONTRIBUTORS BE LIABLE FOR ANY DIRECT, INDIRECT, INCIDENTAL, SPECIAL, EXEMPLARY, OR CONSEQUENTIAL DAMAGES (INCLUDING, BUT NOT LIMITED TO, PROCUREMENT OF SUBSTITUTE GOODS OR SERVICES; LOSS OF USE, DATA, OR PROFITS; OR BUSINESS INTERRUPTION) HOWEVER CAUSED AND ON ANY THEORY OF LIABILITY, WHETHER IN CONTRACT, STRICT LIABILITY, OR TORT (INCLUDING NEGLIGENCE OR OTHERWISE) ARISING IN ANY WAY OUT OF THE USE OF THIS SOFTWARE, EVEN IF ADVISED OF THE POSSIBILITY OF SUCH DAMAGE.

Part 6: Cisco/BUPTNIC copyright notice (BSD)

Copyright (c) 2004, Cisco, Inc and Information Network Center of Beijing University of Posts and Telecommunications.

All rights reserved.

Redistribution and use in source and binary forms, with or without modification, are permitted provided that the following conditions are met:

- Redistributions of source code must retain the above copyright notice, this list of conditions and the following disclaimer.

- Redistributions in binary form must reproduce the above copyright notice, this list of conditions and the following disclaimer in the documentation and/or other materials provided with the distribution.
- Neither the name of Cisco, Inc, Beijing University of Posts and Telecommunications, nor the names of their contributors may be used to endorse or promote products derived from this software without specific prior written permission.

THIS SOFTWARE IS PROVIDED BY THE COPYRIGHT HOLDERS AND CONTRIBUTORS "AS IS" AND ANY EXPRESS OR IMPLIED WARRANTIES, INCLUDING, BUT NOT LIMITED TO, THE IMPLIED WARRANTIES OF MERCHANTABILITY AND FITNESS FOR A PARTICULAR PURPOSE ARE DISCLAIMED. IN NO EVENT SHALL THE COPYRIGHT HOLDERS OR CONTRIBUTORS BE LIABLE FOR ANY DIRECT, INDIRECT, INCIDENTAL, SPECIAL, EXEMPLARY, OR CONSEQUENTIAL DAMAGES (INCLUDING, BUT NOT LIMITED TO, PROCUREMENT OF SUBSTITUTE GOODS OR SERVICES; LOSS OF USE, DATA, OR PROFITS; OR BUSINESS INTERRUPTION) HOWEVER CAUSED AND ON ANY THEORY OF LIABILITY, WHETHER IN CONTRACT, STRICT LIABILITY, OR TORT (INCLUDING NEGLIGENCE OR OTHERWISE) ARISING IN ANY WAY OUT OF THE USE OF THIS SOFTWARE, EVEN IF ADVISED OF THE POSSIBILITY OF SUCH DAMAGE.

Part 7: Fabasoft R&D Software GmbH & Co KG copyright notice (BSD)

Copyright (c) Fabasoft R&D Software GmbH & Co KG, 2003

oss@fabasoft.com

Author: Bernhard Penz

Redistribution and use in source and binary forms, with or without modification, are permitted provided that the following conditions are met:

- Redistributions of source code must retain the above copyright notice, this list of conditions and the following disclaimer.
- Redistributions in binary form must reproduce the above copyright notice, this list of conditions and the following disclaimer in the documentation and/or other materials provided with the distribution.
- The name of Fabasoft R&D Software GmbH & Co KG or any of its subsidiaries, brand or product names may not be used to endorse or promote products derived from this software without specific prior written permission.

THIS SOFTWARE IS PROVIDED BY THE COPYRIGHT HOLDER "AS IS" AND ANY EXPRESS OR IMPLIED WARRANTIES, INCLUDING, BUT NOT LIMITED TO, THE IMPLIED WARRANTIES OF MERCHANTABILITY AND FITNESS FOR A PARTICULAR PURPOSE ARE DISCLAIMED. IN NO EVENT SHALL THE COPYRIGHT HOLDER BE LIABLE FOR ANY DIRECT, INDIRECT, INCIDENTAL, SPECIAL, EXEMPLARY, OR CONSEQUENTIAL DAMAGES (INCLUDING, BUT NOT LIMITED TO, PROCUREMENT OF SUBSTITUTE GOODS OR SERVICES; LOSS OF USE, DATA, OR PROFITS; OR BUSINESS INTERRUPTION) HOWEVER CAUSED AND ON ANY THEORY OF LIABILITY, WHETHER IN CONTRACT, STRICT LIABILITY, OR TORT (INCLUDING NEGLIGENCE OR OTHERWISE) ARISING IN ANY WAY OUT OF THE USE OF THIS SOFTWARE, EVEN IF ADVISED OF THE POSSIBILITY OF SUCH DAMAGE.

Part 8: Apple Inc. copyright notice (BSD)

Copyright (c) 2007 Apple Inc.

All rights reserved.

Redistribution and use in source and binary forms, with or without modification, are permitted provided that the following conditions are met:

1. Redistributions of source code must retain the above copyright notice, this list of conditions and the following disclaimer.
2. Redistributions in binary form must reproduce the above copyright notice, this list of conditions and the following disclaimer in the documentation and/or other materials provided with the distribution.
3. Neither the name of Apple Inc. ("Apple") nor the names of its contributors may be used to endorse or promote products derived from this software without specific prior written permission.

THIS SOFTWARE IS PROVIDED BY APPLE AND ITS CONTRIBUTORS "AS IS" AND ANY EXPRESS OR IMPLIED WARRANTIES, INCLUDING, BUT NOT LIMITED TO, THE IMPLIED WARRANTIES OF MERCHANTABILITY AND FITNESS FOR A PARTICULAR PURPOSE ARE DISCLAIMED. IN NO EVENT SHALL APPLE OR ITS CONTRIBUTORS BE LIABLE FOR ANY DIRECT, INDIRECT, INCIDENTAL, SPECIAL, EXEMPLARY, OR CONSEQUENTIAL DAMAGES (INCLUDING, BUT NOT LIMITED TO, PROCUREMENT OF SUBSTITUTE GOODS OR SERVICES; LOSS OF USE, DATA, OR PROFITS; OR BUSINESS INTERRUPTION) HOWEVER CAUSED AND ON ANY THEORY OF LIABILITY, WHETHER IN CONTRACT, STRICT LIABILITY, OR TORT (INCLUDING NEGLIGENCE OR OTHERWISE) ARISING IN ANY WAY OUT OF THE USE OF THIS SOFTWARE, EVEN IF ADVISED OF THE POSSIBILITY OF SUCH DAMAGE.

Part 9: ScienceLogic, LLC copyright notice (BSD)

Copyright (c) 2009, ScienceLogic, LLC

All rights reserved.

Redistribution and use in source and binary forms, with or without modification, are permitted provided that the following conditions are met:

- Redistributions of source code must retain the above copyright notice, this list of conditions and the following disclaimer.
- Redistributions in binary form must reproduce the above copyright notice, this list of conditions and the following disclaimer in the documentation and/or other materials provided with the distribution.
- Neither the name of ScienceLogic, LLC nor the names of its contributors may be used to endorse or promote products derived from this software without specific prior written permission.

THIS SOFTWARE IS PROVIDED BY THE COPYRIGHT HOLDERS AND CONTRIBUTORS "AS IS" AND ANY EXPRESS OR IMPLIED WARRANTIES, INCLUDING, BUT NOT LIMITED TO, THE IMPLIED WARRANTIES OF MERCHANTABILITY AND FITNESS FOR A PARTICULAR

PURPOSE ARE DISCLAIMED. IN NO EVENT SHALL THE COPYRIGHT HOLDERS OR CONTRIBUTORS BE LIABLE FOR ANY DIRECT, INDIRECT, INCIDENTAL, SPECIAL, EXEMPLARY, OR CONSEQUENTIAL DAMAGES (INCLUDING, BUT NOT LIMITED TO, PROCUREMENT OF SUBSTITUTE GOODS OR SERVICES; LOSS OF USE, DATA, OR PROFITS; OR BUSINESS INTERRUPTION) HOWEVER CAUSED AND ON ANY THEORY OF LIABILITY, WHETHER IN CONTRACT, STRICT LIABILITY, OR TORT (INCLUDING NEGLIGENCE OR OTHERWISE) ARISING IN ANY WAY OUT OF THE USE OF THIS SOFTWARE, EVEN IF ADVISED OF THE POSSIBILITY OF SUCH DAMAGE.

GPL/LGPL SOFTWARE LICENSE

The software included in this product contains copyrighted software that is licensed under the GPL/LGPL. You may obtain the complete Corresponding Source code from us for a period of three years after our last shipment of this product by sending email to help.cctv@samsung.com

If you want to obtain the complete Corresponding Source code in the physical medium such as CD-ROM, the cost of physically performing source distribution might be charged.

- GPL S/W
 - Base Kernel, Busybox, Sysvinit, dosfstools
- LGPL S/W
 - glibc, Inetutils

GNU GENERAL PUBLIC LICENSE

Version 2, June 1991

Copyright (C) 1989, 1991 Free Software Foundation, Inc.

51 Franklin Street, Fifth Floor, Boston, MA 02110-1301, USA

Everyone is permitted to copy and distribute verbatim copies of this license document, but changing it is not allowed.

Preamble

The licenses for most software are designed to take away your freedom to share and change it. By contrast, the GNU General Public License is intended to guarantee your freedom to share and change free software-- to make sure the software is free for all its users.

This General Public License applies to most of the Free Software Foundation's software and to any other program whose authors commit to using it. (Some other Free Software Foundation software is covered by the GNU Lesser General Public License instead.) You can apply it to your programs, too.

When we speak of free software, we are referring to freedom, not price.

Our General Public Licenses are designed to make sure that you have the freedom to distribute copies of free software (and charge for this service if you wish), that you receive source code or can get it if you want it, that you can change the software or use pieces of it in new free



programs ; and that you know you can do these things.

To protect your rights, we need to make restrictions that forbid anyone to deny you these rights or to ask you to surrender the rights. These restrictions translate to certain responsibilities for you if you distribute copies of the software, or if you modify it.

For example, if you distribute copies of such a program, whether gratis or for a fee, you must give the recipients all the rights that you have.

You must make sure that they, too, receive or can get the source code. And you must show them these terms so they know their rights.

We protect your rights with two steps :

(1)copyright the software, and (2)offer you this license which gives you legal permission to copy, distribute and/or modify the software.

Also, for each author's protection and ours, we want to make certain that everyone understands that there is no warranty for this free software. If the software is modified by someone else and passed on, we want its recipients to know that what they have is not the original, so that any problems introduced by others will not reflect on the original authors' reputations.

Finally, any free program is threatened constantly by software patents. We wish to avoid the danger that redistributors of a free program will individually obtain patent licenses, in effect making the program proprietary. To prevent this, we have made it clear that any patent must be licensed for everyone's free use or not licensed at all.

The precise terms and conditions for copying, distribution and modification follow.

TERMS AND CONDITIONS FOR COPYING, DISTRIBUTION AND MODIFICATION

Version 2, June 1991 Copyright (C) 1989, 1991 Free Software Foundation, Inc. 51 Franklin St

0. This License applies to any program or other work which contains a notice placed by the copyright holder saying it may be distributed under the terms of this General Public License. The "Program", below, refers to any such program or work, and a "work based on the Program" means either the Program or any derivative work under copyright law : that is to say, a work containing the Program or a portion of it, either verbatim or with modifications and/or translated into another language. (Hereinafter, translation is included without limitation in the term "modification".) Each licensee is addressed as "you".

Activities other than copying, distribution and modification are not covered by this License ; they are outside its scope. The act of running the Program is not restricted, and the output from the Program is covered only if its contents constitute a work based on the Program (independent of having been made by running the Program). Whether that is true depends on what the Program does.

1. You may copy and distribute verbatim copies of the Program's source code as you receive it, in any medium, provided that you conspicuously and appropriately publish on each copy an appropriate copyright notice and disclaimer of warranty; keep intact all the notices that refer to this License and to the absence of any warranty ; and give any other recipients of the Program a copy of this License along with the program. You may charge a fee for the physical act of transferring a copy, and you may at your option

offer warranty protection in exchange for a fee.

2. You may modify your copy or copies of the Program or any portion of it, thus forming a work based on the Program, and copy and distribute such modifications or work under the terms of Section 1 above, provided that you also meet all of these conditions :

- a) You must cause the modified files to carry prominent notices stating that you changed the files and the date of any change.
- b) You must cause any work that you distribute or publish, that in whole or in part contains or is derived from the Program or any part thereof, to be licensed as a whole at no charge to all third parties under the terms of this License.
- c) If the modified program normally reads commands interactively when run, you must cause it, when started running for such interactive use in the most ordinary way, to print or display an announcement including an appropriate copyright notice and a notice that there is no warranty (or else, saying that you provide a warranty) and that users may redistribute the program under these conditions, and telling the user how to view a copy of this License. (Exception:if the Program itself is interactive but does not normally print such an announcement, your work based on the Program is not required to print an announcement.)

These requirements apply to the modified work as a whole. If identifiable sections of that work are not derived from the Program, and can be reasonably considered independent and separate works in themselves, then this License, and its terms, do not apply to those sections when you distribute them as separate works. But when you distribute the same sections as part of a whole which is a work based on the Program, the distribution of the whole must be on the terms of this License, whose permissions for other licensees extend to the entire whole, and thus to each and every part regardless of who wrote it.

Thus, it is not the intent of this section to claim rights or contest your rights to work written entirely by you ; rather, the intent is to exercise the right to control the distribution of derivative or collective works based on the Program. In addition, mere aggregation of another work not based on the Program with the Program (or with a work based on the Program) on a volume of a storage or distribution medium does not bring the other work under the scope of this License.

3. You may copy and distribute the Program (or a work based on it, under Section 2) in object code or executable form under the terms of Sections 1 and 2 above provided that you also do one of the following :

- a) Accompany it with the complete corresponding machine-readable source code, which must be distributed under the terms of Sections 1 and 2 above on a medium customarily used for software interchange ; or,
- b) Accompany it with a written offer, valid for at least three years, to give any third party, for a charge no more than your cost of physically performing source distribution, a complete machine-readable copy of the corresponding source code, to be distributed under the terms of Sections 1 and 2 above on a medium customarily used for software interchange ; or,
- c) Accompany it with the information you received as to the offer to distribute corresponding source code. (This alternative is allowed only for noncommercial

distribution and only if you received the program in object code or executable form with such an offer, in accord with Subsection b above.)

The source code for a work means the preferred form of the work for making modifications to it. For an executable work, complete source code means all the source code for all modules it contains, plus any associated interface definition files, plus the scripts used to control compilation and installation of the executable. However, as a special exception, the source code distributed need not include anything that is normally distributed (in either source or binary form) with the major components (compiler, kernel, and so on) of the operating system on which the executable runs, unless that component itself accompanies the executable.

If distribution of executable or object code is made by offering access to copy from a designated place, then offering equivalent access to copy the source code from the same place counts as distribution of the source code, even though third parties are not compelled to copy the source along with the object code.

4. You may not copy, modify, sublicense, or distribute the Program except as expressly provided under this License. Any attempt otherwise to copy, modify, sublicense or distribute the Program is void, and will automatically terminate your rights under this License. However, parties who have received copies, or rights, from you under this License will not have their licenses terminated so long as such parties remain in full compliance.
5. You are not required to accept this License, since you have not signed it. However, nothing else grants you permission to modify or distribute the Program or its derivative works. These actions are prohibited by law if you do not accept this License. Therefore, by modifying or distributing the Program (or any work based on the Program), you indicate your acceptance of this License to do so, and all its terms and conditions for copying, distributing or modifying the Program or works based on it.
6. Each time you redistribute the Program (or any work based on the Program), the recipient automatically receives a license from the original licensor to copy, distribute or modify the Program subject to these terms and conditions. You may not impose any further restrictions on the recipients' exercise of the rights granted herein. You are not responsible for enforcing compliance by third parties to this License.
7. If, as a consequence of a court judgment or allegation of patent infringement or for any other reason (not limited to patent issues), conditions are imposed on you (whether by court order, agreement or otherwise) that contradict the conditions of this License, they do not excuse you from the conditions of this License. If you cannot distribute so as to satisfy simultaneously your obligations under this License and any other pertinent obligations, then as a consequence you may not distribute the Program at all. For example, if a patent license would not permit royalty-free redistribution of the Program by all those who receive copies directly or indirectly through you, then the only way you could satisfy both it and this License would be to refrain entirely from distribution of the Program.

If any portion of this section is held invalid or unenforceable under any particular circumstance, the balance of the section is intended to apply and the section as a whole is intended to apply in other circumstances. It is not the purpose of this section to induce you to infringe any patents or other property right claims or to contest validity of any such claims; this section has the sole purpose of protecting the integrity of the free software distribution system, which is

implemented by public license practices. Many people have made generous contributions to the wide range of software distributed through that system in reliance on consistent application of that system; it is up to the author/donor to decide if he or she is willing to distribute software through any other system and a licensee cannot impose that choice. This section is intended to make thoroughly clear what is believed to be a consequence of the rest of this License.

8. If the distribution and/or use of the Program is restricted in certain countries either by patents or by copyrighted interfaces, the original copyright holder who places the Program under this License may add an explicit geographical distribution limitation excluding those countries, so that distribution is permitted only in or among countries not thus excluded. In such case, this License incorporates the limitation as if written in the body of this License.
9. The Free Software Foundation may publish revised and/or new versions of the General Public License from time to time. Such new versions will be similar in spirit to the present version, but may differ in detail to address new problems or concerns. Each version is given a distinguishing version number. If the Program specifies a version number of this License which applies to it and "any later version", you have the option of following the terms and conditions either of that version or of any later version published by the Free Software Foundation. If the Program does not specify a version number of this License, you may choose any version ever published by the Free Software Foundation.
10. If you wish to incorporate parts of the Program into other free programs whose distribution conditions are different, write to the author to ask for permission. For software which is copyrighted by the Free Software Foundation, write to the Free Software Foundation; we sometimes make exceptions for this. Our decision will be guided by the two goals of preserving the free status of all derivatives of our free software and of promoting the sharing and reuse of software generally.

NO WARRANTY

11. BECAUSE THE PROGRAM IS LICENSED FREE OF CHARGE, THERE IS NO WARRANTY FOR THE PROGRAM, TO THE EXTENT PERMITTED BY APPLICABLE LAW. EXCEPT WHEN OTHERWISE STATED IN WRITING THE COPYRIGHT HOLDERS AND/OR OTHER PARTIES PROVIDE THE PROGRAM "AS IS" WITHOUT WARRANTY OF ANY KIND, EITHER EXPRESSED OR IMPLIED, INCLUDING, BUT NOT LIMITED TO, THE IMPLIED WARRANTIES OF MERCHANTABILITY AND FITNESS FOR A PARTICULAR PURPOSE. THE ENTIRE RISK AS TO THE QUALITY AND PERFORMANCE OF THE PROGRAM IS WITH YOU. SHOULD THE PROGRAM PROVE DEFECTIVE, YOU ASSUME THE COST OF ALL NECESSARY SERVICING, REPAIR OR CORRECTION.
12. IN NO EVENT UNLESS REQUIRED BY APPLICABLE LAW OR AGREED TO IN WRITING WILL ANY COPYRIGHT HOLDER, OR ANY OTHER PARTY WHO MAY MODIFY AND/OR REDISTRIBUTE DAMAGES, INCLUDING ANY GENERAL, SPECIAL, INCIDENTAL OR CONSEQUENTIAL DAMAGES ARISING OUT OF THE USE OR INABILITY TO USE THE PROGRAM (INCLUDING BUT NOT LIMITED TO LOSS OF DATA OR DATA BEING RENDERED INACCURATE OR LOSSES SUSTAINED BY YOU OR THIRD PARTIES OR A FAILURE OF THE PROGRAM TO OPERATE WITH ANY OTHER PROGRAMS), EVEN IF SUCH HOLDER OR OTHER PARTY HAS BEEN ADVISED OF THE POSSIBILITY OF



SUCH DAMAGES.

END OF TERMS AND CONDITIONS

How to Apply These Terms to Your New Programs

If you develop a new program, and you want it to be of the greatest possible use to the public, the best way to achieve this is to make it free software which everyone can redistribute and change under these terms.

To do so, attach the following notices to the program. It is safest to attach them to the start of each source file to most effectively convey the exclusion of warranty; and each file should have at least the "copyright" line and a pointer to where the full notice is found.

one line to give the program's name and an idea of what it does.

Copyright (C)yyyy name of author

This program is free software; you can redistribute it and/or modify it under the terms of the GNU General Public License as published by the Free Software Foundation; either version 2 of the License, or (at your option) any later version.

This program is distributed in the hope that it will be useful, but WITHOUT ANY WARRANTY; without even the implied warranty of MERCHANTABILITY or FITNESS FOR A PARTICULAR PURPOSE. See the GNU General Public License for more details.

You should have received a copy of the GNU General Public License along with this program; if not, write to the Free Software Foundation, Inc., 51 Franklin Street, Fifth Floor, Boston, MA 02110-1301, USA.

Also add information on how to contact you by electronic and paper mail. If the program is interactive, make it output a short notice like this when it starts in an interactive mode:

Gnomovision version 69,

Copyright (C) year name of author

Gnomovision comes with ABSOLUTELY NO

WARRANTY; for details type 'show w'. This is free software, and you are welcome to redistribute it under certain conditions; type 'show c' for details.

The hypothetical commands 'show w' and 'show c' should show the appropriate parts of the General Public License. Of course, the commands you use may be called something other than 'show w' and 'show c'; they could even be mouse-clicks or menu items-- whatever suits your program.

You should also get your employer (if you work as a programmer) or your school, if any, to sign a "copyright disclaimer" for the program, if necessary. Here is a sample; alter the names:

Yoyodyne, Inc., hereby disclaims all copyright interest in the program 'Gnomovision' (which makes passes at compilers) written by James Hacker.

signature of Ty Coon, 1 April 1989 Ty Coon, President of Vice

This General Public License does not permit incorporating your program into proprietary programs. If your program is a subroutine library, you may consider it more useful to permit linking proprietary applications with the library. If this is what you want to do, use the GNU Lesser General Public License instead of this License.

GNU GENERAL PUBLIC LICENSE

Version 3, 29 June 2007

Copyright © 2007 Free Software Foundation, Inc. <<http://fsf.org/>>

Everyone is permitted to copy and distribute verbatim copies of this license document, but changing it is not allowed.

Preamble

The GNU General Public License is a free, copyleft

license for software and other kinds of works. The licenses for most software and other practical works are designed to take away your freedom to share and change the works.

By contrast, the GNU General Public License is intended to guarantee your freedom to share and change all versions of a program--to make sure it remains free software for all its users.

We, the Free Software Foundation, use the GNU General Public License for most of our software; it applies also to any other work released this way by its authors. You can apply it to your programs, too.

When we speak of free software, we are referring to freedom, not price. Our General Public Licenses are designed to make sure that you have the freedom to distribute copies of free software (and charge for them if you wish), that you receive source code or can get it if you want it, that you can change the software or use pieces of it in new free programs, and that you know you can do these things.

To protect your rights, we need to prevent others from denying you these rights or asking you to surrender the rights. Therefore, you have certain responsibilities if you distribute copies of the software, or if you modify it: responsibilities to respect the freedom of others.

For example, if you distribute copies of such a program, whether gratis or for a fee, you must pass on to the recipients the same freedoms that you received. You must make sure that they, too, receive or can get the source code. And you must show them these terms so they know their rights.

Developers that use the GNU GPL protect your rights with two steps:

(1) assert copyright on the software, and (2) offer you this License giving you legal permission to copy, distribute and/or modify it.

For the developers' and authors' protection, the GPL clearly explains that there is no warranty for this free software. For both users' and authors' sake, the GPL requires that modified versions be marked as changed, so that their problems will not be attributed erroneously to authors of previous versions.

Some devices are designed to deny users access to install or run modified versions of the software inside them, although the manufacturer can do so. This is fundamentally incompatible with the aim of protecting users' freedom to change the software.

The systematic pattern of such abuse occurs in the area of products for individuals to use, which is precisely where it is most unacceptable. Therefore, we have designed this version of the GPL to prohibit the practice for those products. If such problems arise substantially in other domains, we stand ready to extend this provision to those domains in future versions of the GPL, as needed to protect the freedom of users.

Finally, every program is threatened constantly by software patents. States should not allow patents to restrict development and use of software on general-purpose computers, but in those that do, we wish to avoid the special danger that patents applied to a free program could make it effectively proprietary.

To prevent this, the GPL assures that patents cannot be used to render the program non-free.

The precise terms and conditions for copying, distribution and modification follow.

TERMS AND CONDITIONS

0. Definitions.

"This License" refers to version 3 of the GNU General Public License.

"Copyright" also means copyright-like laws that apply to other kinds of works, such as semiconductor masks.

"The Program" refers to any copyrightable work licensed under this License. Each licensee is addressed as "you". "Licensees" and "recipients" may be individuals or organizations.

To "modify" a work means to copy from or adapt all or part of the work in a fashion requiring copyright permission, other than the making of an exact copy. The resulting work is called a "modified version" of the earlier work or a work "based on" the earlier work.

A "covered work" means either the unmodified Program or a work based on the Program.

To "propagate" a work means to do anything with it that, without permission, would make you directly or secondarily liable for infringement under applicable copyright law, except executing it on a computer or modifying a private copy. Propagation includes copying, distribution (with or without modification), making available to the public, and in some countries other activities as well.

To "convey" a work means any kind of propagation that enables other parties to make or receive copies. Mere interaction with a user through a computer network, with no transfer of a copy, is not conveying.

An interactive user interface displays "Appropriate Legal Notices" to the extent that it includes a convenient and prominently visible feature that (1) displays an appropriate copyright notice, and (2) tells the user that there is no warranty for the work (except to the extent that warranties are provided), that licensees may convey the work under this License, and how to view a copy of this License. If the interface presents a list of user commands or options, such as a menu, a prominent item in the list meets this criterion.

1. Source Code.

The "source code" for a work means the preferred form of the work for making modifications to it. "Object code" means any non-source form of a work.

A "Standard Interface" means an interface that either is an official standard defined by a recognized standards body, or, in the case of interfaces specified for a particular programming

language, one that is widely used among developers working in that language.

The "System Libraries" of an executable work include anything, other than the work as a whole, that (a) is included in the normal form of packaging a Major Component, but which is not part of that Major Component, and (b) serves only to enable use of the work with that Major Component, or to implement a Standard Interface for which an implementation is available to the public in source code form. A "Major Component", in this context, means a major essential component (kernel, window system, and so on) of the specific operating system (if any) on which the executable work runs, or a compiler used to produce the work, or an object code interpreter used to run it.

The "Corresponding Source" for a work in object code form means all the source code needed to generate, install, and (for an executable work) run the object code and to modify the work, including scripts to control those activities. However, it does not include the work's System Libraries, or generalpurpose tools or generally available free programs which are used unmodified in performing those activities but which are not part of the work. For example, Corresponding Source includes interface definition files associated with source files for the work, and the source code for shared libraries and dynamically linked subprograms that the work is specifically designed to require, such as by intimate data communication or control flow between those subprograms and other parts of the work.

The Corresponding Source need not include anything that users can regenerate automatically from other parts of the Corresponding Source.

The Corresponding Source for a work in source code form is that same work.

2. Basic Permissions.

All rights granted under this License are granted for the term of copyright on the Program, and are irrevocable provided the stated conditions are met. This License explicitly affirms your unlimited permission to run the unmodified Program. The output from running a covered work is covered by this License only if the output, given its content, constitutes a covered work. This License acknowledges your rights of fair use or other equivalent, as provided by copyright law.

You may make, run and propagate covered works that you do not convey, without conditions so long as your license otherwise remains in force. You may convey covered works to others for the sole purpose of having them make modifications exclusively for you, or provide you with facilities for running those works, provided that you comply with the terms of this License in conveying all material for which you do not control copyright.

Those thus making or running the covered works for you must do so exclusively on your behalf, under your direction and control, on terms that prohibit them from making any copies of your copyrighted material outside their relationship with you.

Conveying under any other circumstances is permitted solely under the conditions stated below. Sublicensing is not allowed; section 10 makes it unnecessary.

3. Protecting Users' Legal Rights From Anti-Circumvention Law.

No covered work shall be deemed part of an effective technological measure under any applicable law fulfilling obligations under article 11 of the WIPO copyright treaty adopted on 20 December 1996, or similar laws prohibiting or restricting circumvention of such measures.

When you convey a covered work, you waive any legal power to forbid circumvention of



technological measures to the extent such circumvention is effected by exercising rights under this License with respect to the covered work, and you disclaim any intention to limit operation or modification of the work as a means of enforcing, against the work's users, your or third parties' legal rights to forbid circumvention of technological measures.

4. Conveying Verbatim Copies.

You may convey verbatim copies of the Program's source code as you receive it, in any medium, provided that you conspicuously and appropriately publish on each copy an appropriate copyright notice; keep intact all notices stating that this License and any non-permissive terms added in accord with section 7 apply to the code; keep intact all notices of the absence of any warranty; and give all recipients a copy of this License along with the Program.

You may charge any price or no price for each copy that you convey, and you may offer support or warranty protection for a fee.

5. Conveying Modified Source Versions.

You may convey a work based on the Program, or the modifications to produce it from the Program, in the form of source code under the terms of section 4, provided that you also meet all of these conditions:

- a) The work must carry prominent notices stating that you modified it, and giving a relevant date.
- b) The work must carry prominent notices stating that it is released under this License and any conditions added under section 7. This requirement modifies the requirement in section 4 to "keep intact all notices".
- c) You must license the entire work, as a whole, under this License to anyone who comes into possession of a copy. This License will therefore apply, along with any applicable section 7 additional terms, to the whole of the work, and all its parts, regardless of how they are packaged. This License gives no permission to license the work in any other way, but it does not invalidate such permission if you have separately received it.
- d) If the work has interactive user interfaces, each must display Appropriate Legal Notices; however, if the Program has interactive interfaces that do not display Appropriate Legal Notices, your work need not make them do so.

A compilation of a covered work with other separate and independent works, which are not by their nature extensions of the covered work, and which are not combined with it such as to form a larger program, in or on a volume of a storage or distribution medium, is called an "aggregate" if the compilation and its resulting copyright are not used to limit the access or legal rights of the compilation's users beyond what the individual works permit. Inclusion of a covered work in an aggregate does not cause this License to apply to the other parts of the aggregate.

6. Conveying Non-Source Forms.

You may convey a covered work in object code form under the terms of sections 4 and 5, provided that you also convey the machine-readable Corresponding Source under the terms of this License, in one of these ways:

- a) Convey the object code in, or embodied in, a physical product (including a physical

distribution medium), accompanied by the Corresponding Source fixed on a durable physical medium customarily used for software interchange.

- b) Convey the object code in, or embodied in, a physical product (including a physical distribution medium), accompanied by a written offer, valid for at least three years and valid for as long as you offer spare parts or customer support for that product model, to give anyone who possesses the object code either (1) a copy of the Corresponding Source for all the software in the product that is covered by this License, on a durable physical medium customarily used for software interchange, for a price no more than your reasonable cost of physically performing this conveying of source, or (2) access to copy the Corresponding Source from a network server at no charge.
- c) Convey individual copies of the object code with a copy of the written offer to provide the corresponding Source. This alternative is allowed only occasionally and noncommercially, and only if you received the object code with such an offer, in accord with subsection 6b.
- d) Convey the object code by offering access from a designated place (gratis or for a charge), and offer equivalent access to the Corresponding Source in the same way through the same place at no further charge. You need not require recipients to copy the Corresponding Source along with the object code. If the place to copy the object code is a network server, the Corresponding Source may be on a different server (operated by you or a third party) that supports equivalent copying facilities, provided you maintain clear directions next to the object code saying where to find the Corresponding Source. Regardless of what server hosts the Corresponding Source, you remain obligated to ensure that it is available for as long as needed to satisfy these requirements.
- e) Convey the object code using peer-to-peer transmission, provided you inform other peers where the object code and Corresponding Source of the work are being offered to the general public at no charge under subsection 6d.

A separable portion of the object code, whose source code is excluded from the Corresponding Source as a System Library, need not be included in conveying the object code work.

A "User Product" is either (1) a "consumer product", which means any tangible personal property which is normally used for personal, family, or household purposes, or (2) anything designed or sold for incorporation into a dwelling. In determining whether a product is a consumer product, doubtful cases shall be resolved in favor of coverage. For a particular product received by a particular user, "normally used" refers to a typical or common use of that class of product, regardless of the status of the particular user or of the way in which the particular user actually uses, or expects to use, the product. A product is a consumer product regardless of whether the product has substantial commercial, industrial or non-consumer uses, unless such uses represent the only significant mode of use of the product.

"Installation Information" for a User Product means any methods, procedures, authorization keys, or other information required to install and execute modified versions of a covered work in that User Product from a modified version of its Corresponding Source. The information must suffice to ensure that the continued functioning of the modified object code is in no case prevented or interfered with solely because modification has been made.

If you convey an object code work under this section in, or with, or specifically for use in, a User Product, and the conveying occurs as part of a transaction in which the right of

possession and use of the User Product is transferred to the recipient in perpetuity or for a fixed term (regardless of how the transaction is characterized), the Corresponding Source conveyed under this section must be accompanied by the Installation Information. But this requirement does not apply if neither you nor any third party retains the ability to install modified object code on the User Product (for example, the work has been installed in ROM).

The requirement to provide Installation Information does not include a requirement to continue to provide support service, warranty, or updates for a work that has been modified or installed by the recipient, or for the User Product in which it has been modified or installed. Access to a network may be denied when the modification itself materially and adversely affects the operation of the network or violates the rules and protocols for communication across the network.

Corresponding Source conveyed, and Installation Information provided, in accord with this section must be in a format that is publicly documented (and with an implementation available to the public in source code form), and must require no special password or key for unpacking, reading or copying.

7. Additional Terms.

“Additional permissions” are terms that supplement the terms of this License by making exceptions from one or more of its conditions. Additional permissions that are applicable to the entire Program shall be treated as though they were included in this License, to the extent that they are valid under applicable law. If additional permissions apply only to part of the Program, that part may be used separately under those permissions, but the entire Program remains governed by this License without regard to the additional permissions.

When you convey a copy of a covered work, you may at your option remove any additional permissions from that copy, or from any part of it. (Additional permissions may be written to require their own removal in certain cases when you modify the work.) You may place additional permissions on material, added by you to a covered work, for which you have or can give appropriate copyright permission.

Notwithstanding any other provision of this License, for material you add to a covered work, you may (if authorized by the copyright holders of that material) supplement the terms of this License with terms:

- a) Disclaiming warranty or limiting liability differently from the terms of sections 15 and 16 of this License; or
- b) Requiring preservation of specified reasonable legal notices or author attributions in that material or in the Appropriate Legal Notices displayed by works containing it; or
- c) Prohibiting misrepresentation of the origin of that material, or requiring that modified versions of such material be marked in reasonable ways as different from the original version; or
- d) Limiting the use for publicity purposes of names of licensors or authors of the material; or
- e) Declining to grant rights under trademark law for use of some trade names, trademarks, or service marks; or
- f) Requiring indemnification of licensors and authors of that material by anyone who conveys the material (or modified versions of it) with contractual assumptions of liability to the recipient, for any liability that these contractual assumptions directly impose on those

licensors and authors.

All other non-permissive additional terms are considered “further restrictions” within the meaning of section 10. If the Program as you received it, or any part of it, contains a notice stating that it is governed by this License along with a term that is a further restriction, you may remove that term. If a license document contains a further restriction but permits relicensing or conveying under this License, you may add to a covered work material governed by the terms of that license document, provided that the further restriction does not survive such relicensing or conveying.

If you add terms to a covered work in accord with this section, you must place, in the relevant source files, a statement of the additional terms that apply to those files, or a notice indicating where to find the applicable terms.

Additional terms, permissive or non-permissive, may be stated in the form of a separately written license, or stated as exceptions; the above requirements apply either way.

8. Termination.

You may not propagate or modify a covered work except as expressly provided under this License. Any attempt otherwise to propagate or modify it is void, and will automatically terminate your rights under this License (including any patent licenses granted under the third paragraph of section 11).

However, if you cease all violation of this License, then your license from a particular copyright holder is reinstated (a) provisionally, unless and until the copyright holder explicitly and finally terminates your license, and (b) permanently, if the copyright holder fails to notify you of the violation by some reasonable means prior to 60 days after the cessation.

Moreover, your license from a particular copyright holder is reinstated permanently if the copyright holder notifies you of the violation by some reasonable means, this is the first time you have received notice of violation of this License (for any work) from that copyright holder, and you cure the violation prior to 30 days after your receipt of the notice.

Termination of your rights under this section does not terminate the licenses of parties who have received copies or rights from you under this License. If your rights have been terminated and not permanently reinstated, you do not qualify to receive new licenses for the same material under section 10.

9. Acceptance Not Required for Having Copies.

You are not required to accept this License in order to receive or run a copy of the Program. Ancillary propagation of a covered work occurring solely as a consequence of using peer-to-peer transmission to receive a copy likewise does not require acceptance. However, nothing other than this License grants you permission to propagate or modify any covered work. These actions infringe copyright if you do not accept this License. Therefore, by modifying or propagating a covered work, you indicate your acceptance of this License to do so.

10. Automatic Licensing of Downstream Recipients.

Each time you convey a covered work, the recipient automatically receives a license from the original licensors, to run, modify and propagate that work, subject to this License. You are not responsible for enforcing compliance by third parties with this License.

An “entity transaction” is a transaction transferring control of an organization, or substantially all

assets of one, or subdividing an organization, or merging organizations. If propagation of a covered work results from an entity transaction, each party to that transaction who receives a copy of the work also receives whatever licenses to the work the party's predecessor in interest had or could give under the previous paragraph, plus a right to possession of the Corresponding Source of the work from the predecessor in interest, if the predecessor has it or can get it with reasonable efforts.

You may not impose any further restrictions on the exercise of the rights granted or affirmed under this License. For example, you may not impose a license fee, royalty, or other charge for exercise of rights granted under this License, and you may not initiate litigation (including a cross-claim or counterclaim in a lawsuit) alleging that any patent claim is infringed by making, using, selling, offering for sale, or importing the Program or any portion of it.

11. Patents.

A "contributor" is a copyright holder who authorizes use under this License of the Program or a work on which the Program is based. The work thus licensed is called the contributor's "contributor version".

A contributor's "essential patent claims" are all patent claims owned or controlled by the contributor, whether already acquired or hereafter acquired, that would be infringed by some manner, permitted by this License, of making, using, or selling its contributor version, but do not include claims that would be infringed only as a consequence of further modification of the contributor version. For purposes of this definition, "control" includes the right to grant patent sublicenses in a manner consistent with the requirements of this License.

Each contributor grants you a non-exclusive, worldwide, royalty-free patent license under the contributor's essential patent claims, to make, use, sell, offer for sale, import and otherwise run, modify and propagate the contents of its contributor version.

In the following three paragraphs, a "patent license" is any express agreement or commitment, however denominated, not to enforce a patent (such as an express permission to practice a patent or covenant not to sue for patent infringement). To "grant" such a patent license to a party means to make such an agreement or commitment not to enforce a patent against the party.

If you convey a covered work, knowingly relying on a patent license, and the Corresponding Source of the work is not available for anyone to copy, free of charge and under the terms of this License, through a publicly available network server or other readily accessible means, then you must either (1) cause the Corresponding Source to be so available, or (2) arrange to deprive yourself of the benefit of the patent license for this particular work, or (3) arrange, in a manner consistent with the requirements of this License, to extend the patent license to downstream recipients. "Knowingly relying" means you have actual knowledge that, but for the patent license, your conveying the covered work in a country, or your recipient's use of the covered work in a country, would infringe one or more identifiable patents in that country that you have reason to believe are valid.

If, pursuant to or in connection with a single transaction or arrangement, you convey, or propagate by procuring conveyance of, a covered work, and grant a patent license to some of the parties receiving the covered work authorizing them to use, propagate, modify or convey a specific copy of the covered work, then the patent license you grant is automatically extended to all recipients of the covered work and works based on it.

A patent license is "discriminatory" if it does not include within the scope of its coverage,

prohibits the exercise of, or is conditioned on the non-exercise of one or more of the rights that are specifically granted under this License. You may not convey a covered work if you are a party to an arrangement with a third party that is in the business of distributing software, under which you make payment to the third party based on the extent of your activity of conveying the work, and under which the third party grants, to any of the parties who would receive the covered work from you, a discriminatory patent license

- a) in connection with copies of the covered work conveyed by you (or copies made from those copies), or
- b) primarily for and in connection with specific products or compilations that contain the covered work, unless you entered into that arrangement, or that patent license was granted, prior to 28 March 2007.

Nothing in this License shall be construed as excluding or limiting any implied license or other defenses to infringement that may otherwise be available to you under applicable patent law.

12. No Surrender of Others' Freedom.

If conditions are imposed on you (whether by court order, agreement or otherwise) that contradict the conditions of this License, they do not excuse you from the conditions of this License. If you cannot convey a covered work so as to satisfy simultaneously your obligations under this License and any other pertinent obligations, then as a consequence you may not convey it at all. For example, if you agree to terms that obligate you to collect a royalty for further conveying from those to whom you convey the Program, the only way you could satisfy both those terms and this License would be to refrain entirely from conveying the Program.

13. Use with the GNU Affero General Public License.

Notwithstanding any other provision of this License, you have permission to link or combine any covered work with a work licensed under version 3 of the GNU Affero General Public License into a single combined work, and to convey the resulting work. The terms of this License will continue to apply to the part which is the covered work, but the special requirements of the GNU Affero General Public License, section 13, concerning interaction through a network will apply to the combination as such.

14. Revised Versions of this License.

The Free Software Foundation may publish revised and/ or new versions of the GNU General Public License from time to time. Such new versions will be similar in spirit to the present version, but may differ in detail to address new problems or concerns.

Each version is given a distinguishing version number. If the Program specifies that a certain numbered version of the GNU General Public License "or any later version" applies to it, you have the option of following the terms and conditions either of that numbered version or, if you have the option of following the terms and conditions of a later version published by the Free Software Foundation, the later version. If the Program does not specify a version number of the GNU General Public License, you may choose any version ever published by the Free Software Foundation.

If the Program specifies that a proxy can decide which future versions of the GNU General Public License can be used, that proxy's public statement of acceptance of a version permanently authorizes you to choose that version for the Program.

Later license versions may give you additional or different permissions. However, no additional obligations are imposed on any author or copyright holder as a result of your choosing to follow

a later version.

15. Disclaimer of Warranty.

THERE IS NO WARRANTY FOR THE PROGRAM, TO THE EXTENT PERMITTED BY APPLICABLE LAW. EXCEPT WHEN OTHERWISE STATED IN WRITING THE COPYRIGHT HOLDERS AND/OR OTHER PARTIES PROVIDE THE PROGRAM "AS IS" WITHOUT WARRANTY OF ANY KIND, EITHER EXPRESSED OR IMPLIED, INCLUDING, BUT NOT LIMITED TO, THE IMPLIED WARRANTIES OF MERCHANTABILITY AND FITNESS FOR A PARTICULAR PURPOSE. THE ENTIRE RISK AS TO THE QUALITY AND PERFORMANCE OF THE PROGRAM IS WITH YOU. SHOULD THE PROGRAM PROVE DEFECTIVE, YOU ASSUME THE COST OF ALL NECESSARY SERVICING, REPAIR OR CORRECTION.

16. Limitation of Liability.

IN NO EVENT UNLESS REQUIRED BY APPLICABLE LAW OR AGREED TO IN WRITING WILL ANY COPYRIGHT HOLDER, OR ANY OTHER PARTY WHO MODIFIES AND/OR CONVEYS THE PROGRAM AS PERMITTED ABOVE, BE LIABLE TO YOU FOR DAMAGES, INCLUDING ANY GENERAL, SPECIAL, INCIDENTAL OR CONSEQUENTIAL DAMAGES ARISING OUT OF THE USE OR INABILITY TO USE THE PROGRAM (INCLUDING BUT NOT LIMITED TO LOSS OF DATA OR DATA BEING RENDERED INACCURATE OR LOSSES SUSTAINED BY YOU OR THIRD PARTIES OR A FAILURE OF THE PROGRAM TO OPERATE WITH ANY OTHER PROGRAMS), EVEN IF SUCH HOLDER OR OTHER PARTY HAS BEEN ADVISED OF THE POSSIBILITY OF SUCH DAMAGES.

17. Interpretation of Sections 15 and 16.

If the disclaimer of warranty and limitation of liability provided above cannot be given local legal effect according to their terms, reviewing courts shall apply local law that most closely approximates an absolute waiver of all civil liability in connection with the Program, unless a warranty or assumption of liability accompanies a copy of the Program in return for a fee.

END OF TERMS AND CONDITIONS

GNU LESSER GENERAL PUBLIC LICENSE

Version 2.1, February 1999

Copyright (C) 1991, 1999 Free Software Foundation, Inc. 51 Franklin Street, Fifth Floor, Boston, MA 02110-1301

USA Everyone is permitted to copy and distribute verbatim copies of this license document, but changing it is not allowed.

[This is the first released version of the Lesser GPL. It also counts as the successor of the GNU Library Public License, version 2, hence the version number 2.1.]

Preamble

The licenses for most software are designed to take away your freedom to share and change it. By contrast, the GNU General Public Licenses are intended to guarantee your freedom to

share and change free software to make sure the software is free for all its users.

This license, the Lesser General Public License, applies to some specially designated software packages—typically libraries—of the Free Software Foundation and other authors who decide to use it. You can use it too, but we suggest you first think carefully about whether this license or the ordinary General Public License is the better strategy to use in any particular case, based on the explanations below.

When we speak of free software, we are referring to freedom of use, not price. Our General Public Licenses are designed to make sure that you have the freedom to distribute copies of free software (and charge for this service if you wish); that you receive source code or can get it if you want it; that you can change the software and use pieces of it in new free programs; and that you are informed that you can do these things.

To protect your rights, we need to make restrictions that forbid distributors to deny you these rights or to ask you to surrender these rights. These restrictions translate to certain responsibilities for you if you distribute copies of the library or if you modify it.

For example, if you distribute copies of the library, whether gratis or for a fee, you must give the recipients all the rights that we gave you. You must make sure that they, too, receive or can get the source code. If you link other code with the library, you must provide complete object files to the recipients, so that they can relink them with the library after making changes to the library and recompiling it. And you must show them these terms so they know their rights.

We protect your rights with a two-step method: (1) we copyright the library, and (2) we offer you this license, which gives you legal permission to copy, distribute and/or modify the library.

To protect each distributor, we want to make it very clear that there is no warranty for the free library. Also, if the library is modified by someone else and passed on, the recipients should know that what they have is not the original version, so that the original author's reputation will not be affected by problems that might be introduced by others.

Finally, software patents pose a constant threat to the existence of any free program. We wish to make sure that a company cannot effectively restrict the users of a free program by obtaining a restrictive license from a patent holder. Therefore, we insist that any patent license obtained for a version of the library must be consistent with the full freedom of use specified in this license.

Most GNU software, including some libraries, is covered by the ordinary GNU General Public License. This license, the GNU Lesser General Public License, applies to certain designated libraries, and is quite different from the ordinary General Public License. We use this license for certain libraries in order to permit linking those libraries into non-free programs.

When a program is linked with a library, whether statically or using a shared library, the combination of the two is legally speaking a combined work, a derivative of the original library. The ordinary General Public License therefore permits such linking only if the entire combination fits its criteria of freedom. The Lesser General Public License permits more lax criteria for linking other code with the library.

We call this license the "Lesser" General Public License because it does Less to protect the user's freedom than the ordinary General Public License. It also provides other free software developers Less of an advantage over competing non-free programs. These disadvantages are the reason we use the ordinary General Public License for many libraries. However, the Lesser license provides advantages in certain special circumstances.

For example, on rare occasions, there may be a special need to encourage the widest possible



use of a certain library, so that it becomes a de-facto standard. To achieve this, non-free programs must be allowed to use the library. A more frequent case is that a free library does the same job as widely used non-free libraries. In this case, there is little to gain by limiting the free library to free software only, so we use the Lesser General Public License.

In other cases, permission to use a particular library in non-free programs enables a greater number of people to use a large body of free software. For example, permission to use the GNU C Library in non-free programs enables many more people to use the whole GNU operating system, as well as its variant, the GNU/ Linux operating system.

Although the Lesser General Public License is Less protective of the users' freedom, it does ensure that the user of a program that is linked with the Library has the freedom and the wherewithal to run that program using a modified version of the Library.

The precise terms and conditions for copying, distribution and modification follow. Pay close attention to the difference between a "work based on the library" and a "work that uses the library". The former contains code derived from the library, whereas the latter must be combined with the library in order to run.

TERMS AND CONDITIONS FOR COPYING, DISTRIBUTION AND MODIFICATION

0. This License Agreement applies to any software library or other program which contains a notice placed by the copyright holder or other authorized party saying it may be distributed under the terms of this Lesser General Public License (also called "this License"). Each licensee is addressed as "you".

A "library" means a collection of software functions and/ or data prepared so as to be conveniently linked with application programs (which use some of those functions and data) to form executables.

The "Library", below, refers to any such software library or work which has been distributed under these terms. A "work based on the Library" means either the Library or any derivative work under copyright law: that is to say, a work containing the Library or a portion of it, either verbatim or with modifications and/or translated straightforwardly into another language. (Hereinafter, translation is included without limitation in the term "modification".)

"Source code" for a work means the preferred form of the work for making modifications to it. For a library, complete source code means all the source code for all modules it contains, plus any associated interface definition files, plus the scripts used to control compilation and installation of the library.

Activities other than copying, distribution and modification are not covered by this License; they are outside its scope. The act of running a program using the Library is not restricted, and output from such a program is covered only if its contents constitute a work based on the Library (independent of the use of the Library in a tool for writing it). Whether that is true depends on what the Library does and what the program that uses the Library does.

1. You may copy and distribute verbatim copies of the Library's complete source code as you receive it, in any medium, provided that you conspicuously and appropriately publish on each copy an appropriate copyright notice and disclaimer of warranty; keep intact all the notices that refer to this License and to the absence of any warranty; and distribute a copy of this License along with the Library.

You may charge a fee for the physical act of transferring a copy, and you may at your option offer warranty protection in exchange for a fee.

2. You may modify your copy or copies of the Library or any portion of it, thus forming a work based on the Library, and copy and distribute such modifications or work under the terms of Section 1 above, provided that you also meet all of these conditions:

- a) The modified work must itself be a software library.
- b) You must cause the files modified to carry prominent notices stating that you changed the files and the date of any change.
- c) You must cause the whole of the work to be licensed at no charge to all third parties under the terms of this License.
- d) If a facility in the modified Library refers to a function or a table of data to be supplied by an application program that uses the facility, other than as an argument passed when the facility is invoked, then you must make a good faith effort to ensure that, in the event an application does not supply such function or table, the facility still operates, and performs whatever part of its purpose remains meaningful.

(For example, a function in a library to compute square roots has a purpose that is entirely well-defined independent of the application. Therefore, Subsection 2d requires that any application-supplied function or table used by this function must be optional: if the application does not supply it, the square root function must still compute square roots.)

These requirements apply to the modified work as a whole. If identifiable sections of that work are not derived from the Library, and can be reasonably considered independent and separate works in themselves, then this License, and its terms, do not apply to those sections when you distribute them as separate works. But when you distribute the same sections as part of a whole which is a work based on the Library, the distribution of the whole must be on the terms of this License, whose permissions for other licensees extend to the entire whole, and thus to each and every part regardless of who wrote it.

Thus, it is not the intent of this section to claim rights or contest your rights to work written entirely by you; rather, the intent is to exercise the right to control the distribution of derivative or collective works based on the Library.

In addition, mere aggregation of another work not based on the Library with the Library (or with a work based on the Library) on a volume of a storage or distribution medium does not bring the other work under the scope of this License.

3. You may opt to apply the terms of the ordinary GNU General Public License instead of this License to a given copy of the Library. To do this, you must alter all the notices that refer to this License, so that they refer to the ordinary GNU General Public License, version 2, instead of to this License. (If a newer version than version 2 of the ordinary GNU General Public License has appeared, then you can specify that version instead if you wish.) Do not make any other change in these notices.

Once this change is made in a given copy, it is irreversible for that copy, so the ordinary GNU General Public License applies to all subsequent copies and derivative works made from that copy.

This option is useful when you wish to copy part of the code of the Library into a program that is not a library.

4. You may copy and distribute the Library (or a portion or derivative of it, under Section 2) in object code or executable form under the terms of Sections 1 and 2 above provided that

you accompany it with the complete corresponding machine-readable source code, which must be distributed under the terms of Sections 1 and 2 above on a medium customarily used for software interchange.

If distribution of object code is made by offering access to copy from a designated place, then offering equivalent access to copy the source code from the same place satisfies the requirement to distribute the source code, even though third parties are not compelled to copy the source along with the object code.

5. A program that contains no derivative of any portion of the Library, but is designed to work with the Library by being compiled or linked with it, is called a “work that uses the Library”. Such a work, in isolation, is not a derivative work of the Library, and therefore falls outside the scope of this License.

However, linking a “work that uses the Library” with the Library creates an executable that is a derivative of the Library (because it contains portions of the Library), rather than a “work that uses the library”.

The executable is therefore covered by this License. Section 6 states terms for distribution of such executables.

When a “work that uses the Library” uses material from a header file that is part of the Library, the object code for the work may be a derivative work of the Library even though the source code is not. Whether this is true is especially significant if the work can be linked without the Library, or if the work is itself a library. The threshold for this to be true is not precisely defined by law.

If such an object file uses only numerical parameters, data structure layouts and accessors, and small macros and small inline functions (ten lines or less in length), then the use of the object file is unrestricted, regardless of whether it is legally a derivative work. (Executables containing this object code plus portions of the Library will still fall under Section 6.)

Otherwise, if the work is a derivative of the Library, you may distribute the object code for the work under the terms of Section 6. Any executables containing that work also fall under Section 6, whether or not they are linked directly with the Library itself.

6. As an exception to the Sections above, you may also combine or link a “work that uses the Library” with the Library to produce a work containing portions of the Library, and distribute that work under terms of your choice, provided that the terms permit modification of the work for the customer’s own use and reverse engineering for debugging such modifications.

You must give prominent notice with each copy of the work that the Library is used in it and that the Library and its use are covered by this License. You must supply a copy of this License. If the work during execution displays copyright notices, you must include the copyright notice for the Library among them, as well as a reference directing the user to the copy of this License. Also, you must do one of these things:

a) Accompany the work with the complete corresponding machine-readable source code for the Library including whatever changes were used in the work (which must be distributed under Sections 1 and 2 above); and, if the work is an executable linked with the Library, with the complete machine readable “work that uses the Library”, as object code and/or source code, so that the user can modify the Library and then relink to produce a modified executable containing the modified Library. (It is understood that the user who changes the contents of definitions files in the Library will not necessarily be able to recompile the application to use the modified definitions.)

- b) Use a suitable shared library mechanism for linking with the Library. A suitable mechanism is one that (1) uses at run time a copy of the library already present on the user’s computer system, rather than copying library functions into the executable, and (2) will operate properly with a modified version of the library, if the user installs one, as long as the modified version is interface-compatible with the version that the work was made with.
- c) Accompany the work with a written offer, valid for at least three years, to give the same user the materials specified in Subsection 6a, above, for a charge no more than the cost of performing this distribution.
- d) If distribution of the work is made by offering access to copy from a designated place, offer equivalent access to copy the above specified materials from the same place.
- e) Verify that the user has already received a copy of these materials or that you have already sent this user a copy.

For an executable, the required form of the “work that uses the Library” must include any data and utility programs needed for reproducing the executable from it. However, as a special exception, the materials to be distributed need not include anything that is normally distributed (in either source or binary form) with the major components (compiler, kernel, and so on) of the operating system on which the executable runs, unless that component itself accompanies the executable.

It may happen that this requirement contradicts the license restrictions of other proprietary libraries that do not normally accompany the operating system. Such a contradiction means you cannot use both them and the Library together in an executable that you distribute.

- 7. You may place library facilities that are a work based on the Library side-by-side in a single library together with other library facilities not covered by this License, and distribute such a combined library, provided that the separate distribution of the work based on the Library and of the other library facilities is otherwise permitted, and provided that you do these two things:
 - a) Accompany the combined library with a copy of the same work based on the Library, uncombined with any other library facilities. This must be distributed under the terms of the Sections above.
 - b) Give prominent notice with the combined library of the fact that part of it is a work based on the Library, and explaining where to find the accompanying uncombined form of the same work.
- 8. You may not copy, modify, sublicense, link with, or distribute the Library except as expressly provided under this License. Any attempt otherwise to copy, modify, sublicense, link with, or distribute the Library is void, and will automatically terminate your rights under this License. However, parties who have received copies, or rights, from you under this License will not have their licenses terminated so long as such parties remain in full compliance.
- 9. You are not required to accept this License, since you have not signed it. However, nothing else grants you permission to modify or distribute the Library or its derivative works. These actions are prohibited by law if you do not accept this License. Therefore, by modifying or distributing the Library (or any work based on the Library), you indicate your acceptance of this License to do so, and all its terms and conditions for copying, distributing or modifying the Library or works based on it.



10. Each time you redistribute the Library (or any work based on the Library), the recipient automatically receives a license from the original licensor to copy, distribute, link with or modify the Library subject to these terms and conditions. You may not impose any further restrictions on the recipients' exercise of the rights granted herein. You are not responsible for enforcing compliance by third parties with this License.
11. If, as a consequence of a court judgment or allegation of patent infringement or for any other reason (not limited to patent issues), conditions are imposed on you (whether by court order, agreement or otherwise) that contradict the conditions of this License, they do not excuse you from the conditions of this License. If you cannot distribute so as to satisfy simultaneously your obligations under this License and any other pertinent obligations, then as a consequence you may not distribute the Library at all. For example, if a patent license would not permit royalty free redistribution of the Library by all those who receive copies directly or indirectly through you, then the only way you could satisfy both it and this License would be to refrain entirely from distribution of the Library.

If any portion of this section is held invalid or unenforceable under any particular circumstance, the balance of the section is intended to apply, and the section as a whole is intended to apply in other circumstances.

It is not the purpose of this section to induce you to infringe any patents or other property rights claims or to contest validity of any such claims; this section has the sole purpose of protecting the integrity of the free software distribution system which is

implemented by public license practices. Many people have made generous contributions to the wide range of software distributed through that system in reliance on consistent application of that system; it is up to the author/donor to decide if he or she is willing to distribute software through any other system and a licensee cannot impose that choice.

This section is intended to make thoroughly clear what is believed to be a consequence of the rest of this License.

12. If the distribution and/or use of the Library is restricted in certain countries either by patents or by copyrighted interfaces, the original copyright holder who places the Library under this License may add an explicit geographical distribution limitation excluding those countries, so that distribution is permitted only in or among countries not thus excluded. In such case, this License incorporates the limitation as if written in the body of this License.
13. The Free Software Foundation may publish revised and/or new versions of the Lesser General Public License from time to time. Such new versions will be similar in spirit to the present version, but may differ in detail to address new problems or concerns.

Each version is given a distinguishing version number. If the Library specifies a version number of this License which applies to it and "any later version", you have the option of following the terms and conditions either of that version or of any later version published by the Free Software Foundation. If the Library does not specify a license version number, you may choose any version ever published by the Free Software Foundation.

14. If you wish to incorporate parts of the Library into other free programs whose distribution conditions are incompatible with these, write to the author to ask for permission. For software which is copyrighted by the Free Software Foundation, write to the Free Software Foundation; we sometimes make exceptions for this. Our decision will be guided by the two goals of preserving the free status of all derivatives of our free software and of promoting the sharing and reuse of software generally.

NO WARRANTY

15. BECAUSE THE LIBRARY IS LICENSED FREE OF CHARGE, THERE IS NO WARRANTY FOR THE LIBRARY, TO THE EXTENT PERMITTED BY APPLICABLE LAW. EXCEPT WHEN OTHERWISE STATED IN WRITING THE COPYRIGHT HOLDERS AND/OR OTHER PARTIES PROVIDE THE LIBRARY "AS IS" WITHOUT WARRANTY OF ANY KIND, EITHER EXPRESSED OR IMPLIED, INCLUDING, BUT NOT LIMITED TO, THE IMPLIED WARRANTIES OF MERCHANTABILITY AND FITNESS FOR A PARTICULAR PURPOSE. THE ENTIRE RISK AS TO THE QUALITY AND PERFORMANCE OF THE LIBRARY IS WITH YOU. SHOULD THE LIBRARY PROVE DEFECTIVE, YOU ASSUME THE COST OF ALL NECESSARY SERVICING, REPAIR OR CORRECTION.
16. IN NO EVENT UNLESS REQUIRED BY APPLICABLE LAW OR AGREED TO IN WRITING WILL ANY COPYRIGHT HOLDER, OR ANY OTHER PARTY WHO MAY MODIFY AND/OR REDISTRIBUTE THE LIBRARY AS PERMITTED ABOVE, BE LIABLE TO YOU FOR DAMAGES, INCLUDING ANY GENERAL, SPECIAL, INCIDENTAL OR CONSEQUENTIAL DAMAGES ARISING OUT OF THE USE OR INABILITY TO USE THE LIBRARY (INCLUDING BUT NOT LIMITED TO LOSS OF DATA OR DATA BEING RENDERED INACCURATE OR LOSSES SUSTAINED BY YOU OR THIRD PARTIES OR A FAILURE OF THE LIBRARY TO OPERATE WITH ANY OTHER SOFTWARE), EVEN IF SUCH HOLDER OR OTHER PARTY HAS BEEN ADVISED OF THE POSSIBILITY OF SUCH DAMAGES.

END OF TERMS AND CONDITIONS

How to Apply These Terms to Your New Libraries

If you develop a new library, and you want it to be of the greatest possible use to the public, we recommend making it free software that everyone can redistribute and change. You can do so by permitting redistribution under these terms (or, alternatively, under the terms of the ordinary General Public License).

To apply these terms, attach the following notices to the library. It is safest to attach them to the start of each source file to most effectively convey the exclusion of warranty; and each file should have at least the "copyright" line and a pointer to where the full notice is found. one line to give the library's name and an idea of what it does.

Copyright (C) year name of author

This library is free software; you can redistribute it and/ or modify it under the terms of the GNU Lesser General Public License as published by the Free Software Foundation; either version 2.1 of the License, or (at your option) any later version.

This library is distributed in the hope that it will be useful, but WITHOUT ANY WARRANTY; without even the implied warranty of MERCHANTABILITY or FITNESS FOR A PARTICULAR PURPOSE.

See the GNU Lesser General Public License for more details.

You should have received a copy of the GNU Lesser General Public License along with this library; if not, write to the Free Software Foundation, Inc., 51 Franklin Street, Fifth Floor, Boston, MA 02110-1301 USA Also add information on how to contact you by electronic and paper mail.

You should also get your employer (if you work as a programmer) or your school, if any, to sign a "copyright disclaimer" for the library, if necessary. Here is a sample; alter the names:

Yoyodyne, Inc., hereby disclaims all copyright interest in the library 'Frob' (a library for tweaking knobs) written by James Random Hacker.

signature of Ty Coon, 1 April 1990 Ty Coon, President of Vice.

OpenSSL LICENSE

Copyright (c) 1998-2006 The OpenSSL Project. All rights reserved. Redistribution and use in source and binary forms, with or without modification, are permitted provided that the following conditions are met:

1. Redistributions of source code must retain the above copyright notice, this list of conditions and the following disclaimer.
2. Redistributions in binary form must reproduce the above copyright notice, this list of conditions and the following disclaimer in the documentation and/or other materials provided with the distribution.
3. All advertising materials mentioning features or use of this software must display the following acknowledgment: "This product includes software developed by the OpenSSL Project for use in the OpenSSL Toolkit. (<http://www.openssl.org/>)"
4. The names "OpenSSL Toolkit" and "OpenSSL Project" must not be used to endorse or promote products derived from this software without prior written permission. For written permission, please contact openssl-core@openssl.org.
5. Products derived from this software may not be called "OpenSSL" nor may "OpenSSL" appear in their names without prior written permission of the OpenSSL Project.
6. Redistributions of any form whatsoever must retain the following acknowledgment: "This product includes software developed by the OpenSSL Project for use in the OpenSSL Toolkit (<http://www.openssl.org/>)"

THIS SOFTWARE IS PROVIDED BY THE OpenSSL PROJECT "AS IS" AND ANY EXPRESSED OR IMPLIED WARRANTIES, INCLUDING, BUT NOT LIMITED TO, THE IMPLIED WARRANTIES OF MERCHANTABILITY AND FITNESS FOR A PARTICULAR PURPOSE ARE DISCLAIMED. IN NO EVENT SHALL THE OpenSSL PROJECT OR ITS CONTRIBUTORS BE LIABLE FOR ANY DIRECT, INDIRECT, INCIDENTAL, SPECIAL, EXEMPLARY, OR CONSEQUENTIAL DAMAGES (INCLUDING, BUT NOT LIMITED TO, PROCUREMENT OF SUBSTITUTE GOODS OR SERVICES; LOSS OF USE, DATA, OR PROFITS; OR BUSINESS INTERRUPTION) HOWEVER CAUSED AND ON ANY THEORY OF LIABILITY, WHETHER IN CONTRACT, STRICT LIABILITY, OR TORT (INCLUDING NEGLIGENCE OR OTHERWISE) ARISING IN ANY WAY OUT OF THE USE OF THIS SOFTWARE, EVEN IF ADVISED OF THE POSSIBILITY OF SUCH DAMAGE. This product includes cryptographic software written by Eric Young (eyay@cryptsoft.com). This product includes software written by Tim Hudson (tjh@cryptsoft.com).

Original SSLeay License

Copyright (C) 1995-1998 Eric Young (eyay@cryptsoft.com) All rights reserved. This package is an SSL implementation written by Eric Young (eyay@cryptsoft.com). The implementation was

written so as to conform with Netscapes SSL. This library is free for commercial and non-commercial use as long as the following conditions are adhered to. The following conditions apply to all code found in this distribution, be it the RC4, RSA, lhash, DES, etc., code; not just the SSL code. The SSL documentation included with this distribution is covered by the same copyright terms except that the holder is Tim Hudson (tjh@cryptsoft.com).

Copyright remains Eric Young's, and as such any Copyright notices in the code are not to be removed. If this package is used in a product, Eric Young should be given attribution as the author of the parts of the library used. This can be in the form of a textual message at program startup or in documentation (online or textual) provided with the package. Redistribution and use in source and binary forms, with or without modification, are permitted provided that the following conditions are met:

1. Redistributions of source code must retain the copyright notice, this list of conditions and the following disclaimer.
2. Redistributions in binary form must reproduce the above copyright notice, this list of conditions and the following disclaimer in the documentation and/or other materials provided with the distribution.
3. All advertising materials mentioning features or use of this software must display the following acknowledgement: "This product includes cryptographic software written by Eric Young (eyay@cryptsoft.com)" The word 'cryptographic' can be left out if the routines from the library being used are not cryptographic related (-).
4. If you include any Windows specific code (or a derivative thereof) from the apps directory (application code) you must include an acknowledgement: "This product includes software written by Tim Hudson (tjh@cryptsoft.com)"

THIS SOFTWARE IS PROVIDED BY ERIC YOUNG "AS IS AND ANY EXPRESS OR IMPLIED WARRANTIES, INCLUDING, BUT NOT LIMITED TO, THE IMPLIED WARRANTIES OF MERCHANTABILITY AND FITNESS FOR A PARTICULAR PURPOSE ARE DISCLAIMED. IN NO EVENT SHALL THE AUTHOR OR CONTRIBUTORS BE LIABLE FOR ANY DIRECT, INDIRECT, INCIDENTAL, SPECIAL, EXEMPLARY, OR CONSEQUENTIAL DAMAGES (INCLUDING, BUT NOT LIMITED TO, PROCUREMENT OF SUBSTITUTE GOODS OR SERVICES; LOSS OF USE, DATA, OR PROFITS; OR BUSINESS INTERRUPTION) HOWEVER CAUSED AND ON ANY THEORY OF LIABILITY, WHETHER IN CONTRACT, STRICT LIABILITY, OR TORT (INCLUDING NEGLIGENCE OR OTHERWISE) ARISING IN ANY WAY OUT OF THE USE OF THIS SOFTWARE, EVEN IF ADVISED OF THE POSSIBILITY OF SUCH DAMAGE.

The licence and distribution terms for any publicly available version or derivative of this code cannot be changed, i.e. this code cannot simply be copied and put under another distribution licence [including the GNU Public Licence.]





한화테크윈은 지구환경보전을 위하여 제품과 관련된 전 과정에서 환경을 고려하고 있으며, 고객에게 보다 친환경적인 제품을 제공하기 위하여 다양한 활동을 추진하고 있습니다.

에코(Eco)마크는 친환경제품을 만들기 위한 한화테크윈의 의지이며, 유럽의 환경규제(RoHS)에 만족하는 제품임을 의미합니다.



한화테크윈(주)

경기도 성남시 분당구 판교로 319번길 6 (삼평동 701)

영 업 TEL 070-7147-8771~9 A/S 및 기술 문의 1588-5772

부산영업소 TEL 051-796-3216

대구영업소 TEL 053-742-3098

광주영업소 TEL 062-941-9559

대전영업소 TEL 042-489-9840

www.wisenetlife.com