

WISENET

DIGITAL VIDEO RECORDER
User Manual

SDR-73306/SDR-74306/SDR-75306

CE

Overview of DVR

CONTENTS

OVERVIEW OF DVR	2	Contents
	3	Safety Instruction
	4	Front Panel
	5	Rear Panel
	6	Remote Controller
	7	Install Hard Drive
	8	Connect external equipment
	8	Connect DVR

2

DVR BOOT UP	9	System Initialization
	9	Login
	9	Startup Wizard
	12	Main Interface

9

DVR MENU	14	Popup Menu
	15	Main Menu Guide
	16	Setup
	22	Registering with DDNS
	32	Shutdown
	32	Menu Lock
	32	Switch User
	32	Search
	32	Split Mode
	32	Start Sequence

14

SEARCH	33	Search
---------------	-----------	--------

33

WISENET CLIENT / WEB	37	System Environment Requirements
	40	Wisenet Client Login
	40	Live Interface

37

APPENDIX	52	Troubleshooting
	54	Specifications
	57	Dimension
	58	Open Source Announcement

52

SAFETY INSTRUCTION



Please carefully read the following safety instruction so as to avoid personal injuries and prevent the equipment and other connection devices from being damaged.

1. Please use the power supply enclosed or specified by the manufacturer.
Never operate the equipment by using unspecified power supply.
2. Never push objects of any kind through openings of DVR so as to avoid electric shock or other accidents.
3. Do not put the equipment in a dusty location.
4. Do not place the equipment under the rain or humid environment like the basement.
If the equipment is accidentally in contact with water, please unplug the power cable and immediately contact technical support.
5. Keep the surface of the equipment clean and dry.
Use a soft damp cloth to clean the outer case of the DVR. (Do not use liquid aerosol cleaners.)
6. Do not operate if any problems are found.
If there is a strange smell or sound from the DVR, unplug the power cable and contact technical support.
7. Do not try to remove the DVR cover to avoid electrical shock.
8. Handle with care.
If DVR does not work properly, please contact technical support for repair or replacement.
9. Install and place the equipment in a well ventilated area. The DVR system includes a HDD, which produces large amount of heat during operation. As a result, do not block the ventilation vents (on the top, bottom, sides and the back of the DVR).
10. The power adapter should only be connected to the DVR. Do not connect it to additional equipment or else the DVR may restart repeatedly due to insufficient power.
11. Do not install near any heat sources such as radiator, stove, and other machinery or devices (including speakers) that produce large amount of heat.
12. If the provided plug does not fit your outlet, please technical support for assistance.
13. Protect the power cord from being walked on or pinched particularly at the plug level and each ends of the cord.
14. Only use attachments/accessories specified by the manufacturer.
15. Only use the cart, stand, tripod, bracket, or table specified by the manufacturer, or sold with the system.
When a cart is used, use caution when moving the cart and the device to avoid injury from tip-over.
16. Unplug the device during lightning storms or when unused for long periods of time.
17. Refer all servicing to qualified service personnel. Servicing is required when the device has been damaged in any way, such as power-supply cord or plug is broken, liquid has been spilled or objects have fallen onto the device, exposed to rain or moisture, does not operate normally, or has been dropped.



Standards Approvals



- 
 - Any changes or modifications in construction of this device which are not expressly approved by the party responsible for compliance could void the user's authority to operate the equipment.
- 
 - This device complies with part 15 of the FCC Rules. Operation is subject to the following two conditions: (1) This device may not cause harmful interference, and (2) this device must accept any interference received, including interference that may cause undesired operation.
 - This equipment has been tested and found to comply with the limits for a Class A digital device, pursuant to part 15 of the FCC Rules. These limits are designed to provide reasonable protection against harmful interference when the equipment is operated in a commercial environment. This equipment generates, uses, and can radiate radio frequency energy and, if not installed and used in accordance with the instruction manual, may cause harmful interference to radio communications. Operation of this equipment in a residential area is likely to cause harmful interference in which case the user will be required to correct the interference at his own expense.

Overview of DVR

FRONT PANEL

DVR is short for Digital Video Recorder.

SDR-73306/SDR-74306/SDR-75306

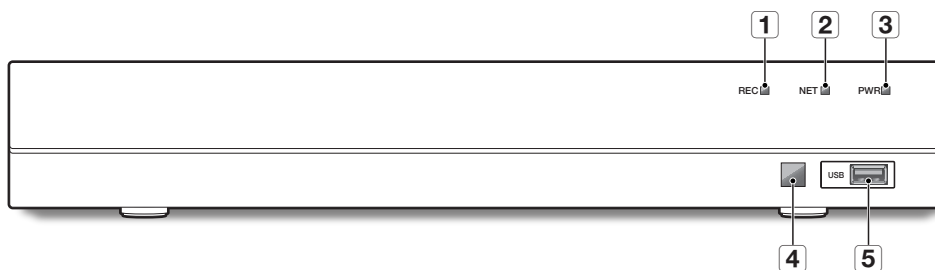

Type	Key or indicator	Identification	Functions	
1	Status lamp	HDD indicator	REC	If the "Red" indicator flashes, the hard drive is being read or written to. ■ The red light will illuminate when HDD is installed.
2		Network indicator	NET	Display network connection and data transfer status.
3		Power indicator	PWR	If the "Blue" indicator is on, DVR is getting power normally.
4	IR port		□	Receive IR signal from Remote Controller.
5	USB port	USB	USB	USB port

REAR PANEL

SDR-73306

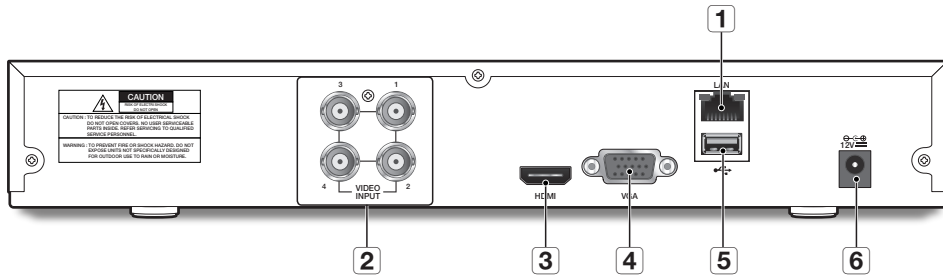

SDR-74306

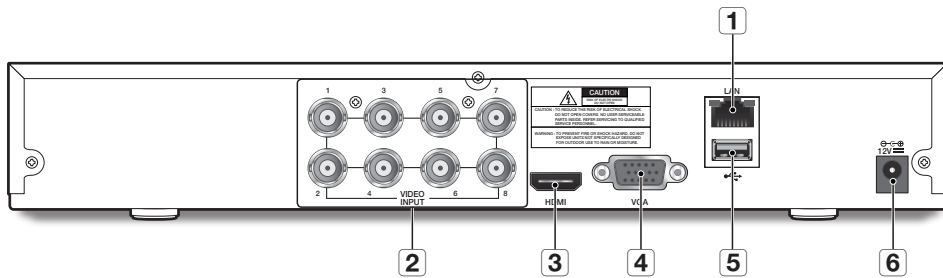

SDR-75306

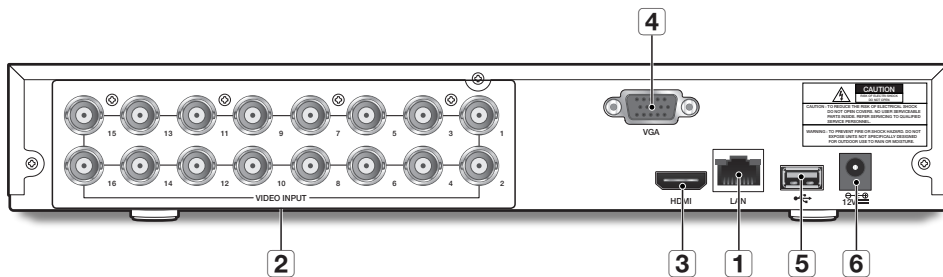

Physical Interface	Connection
1 LAN: (RJ45) Network port	Connect with LAN, Ethernet cable.
2 VIDEO INPUT	Connect with (analog) video input device, standard BNC port.
3 HDMI	Connect with HDMI display devices, such as PC monitor.
4 VGA port	Connect with VGA display devices, such as PC monitor.
5 USB port	Connect with USB.
6 Power port	Connect with the power supply, included with the device.

Overview of DVR

REMOTE CONTROLLER

Operation of remote controller

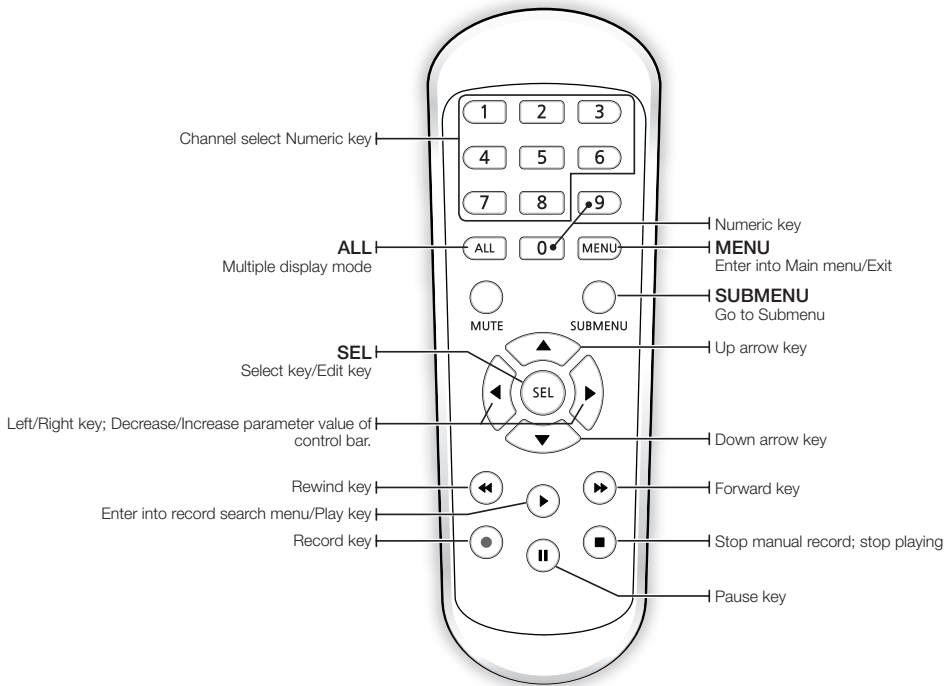

- There is no function of Mute button.
- The administrator is recommended to store the remote control carefully in order to initialize it if the password is lost.

INSTALL HARD DRIVE

-  ■ HDD is pre-installed. If you want to replace hard disk drive, please refer to the following instruction. Please do not remove the hard drive when DVR is operating.

Installation of Hard Drive

1. Using a screwdriver, remove the screws from the side and back panels.

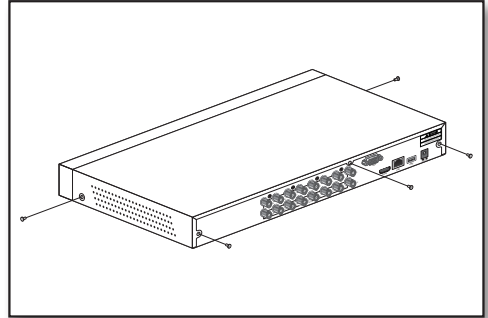

2. Remove the top cover.

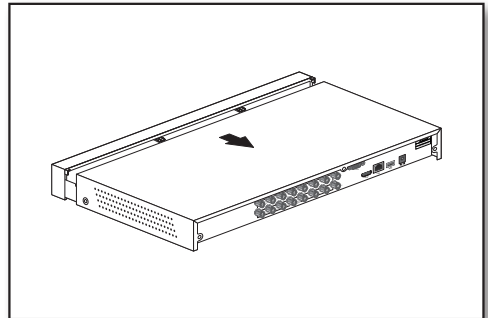

3. Connect data and power cables of hard drive to the motherboard. Mount the hard drive by mounting it onto the rack and connecting the power and data cables.

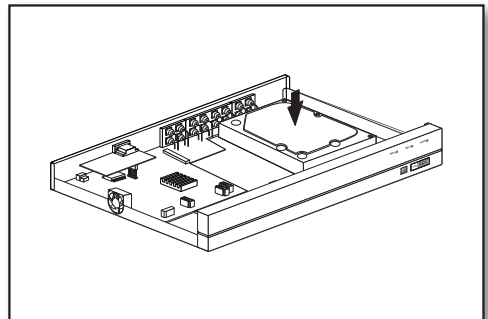

4. Multiple groups of screw mounting holes are provided on the bottom of the DVR. Screw the hard drive in place according to the size of your hard drive.

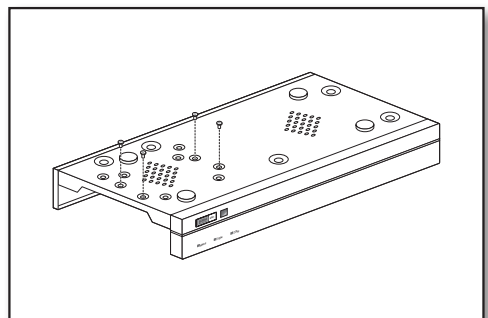

Overview of DVR

CONNECT EXTERNAL EQUIPMENT

Connect your monitor to the DVR using the VGA or HDMI video cable. Connect DVR to the power supply adapter provided. After all connections are completed, plug the DVR in to perform function checks.

- The appearance of power adaptor differs depending on sales region.

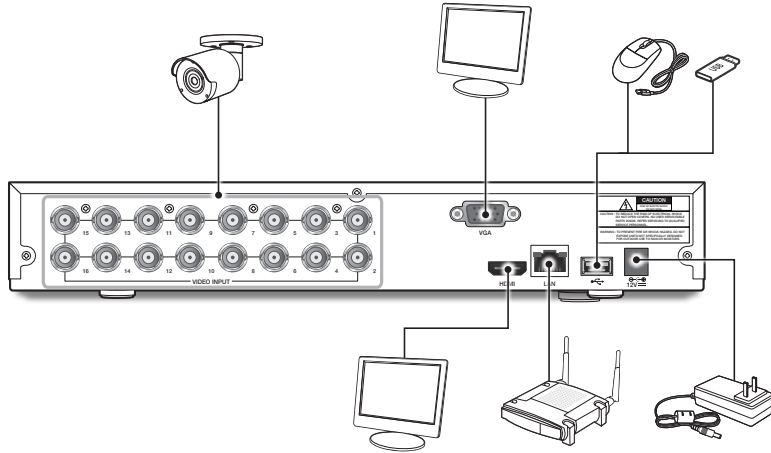

CONNECT DVR

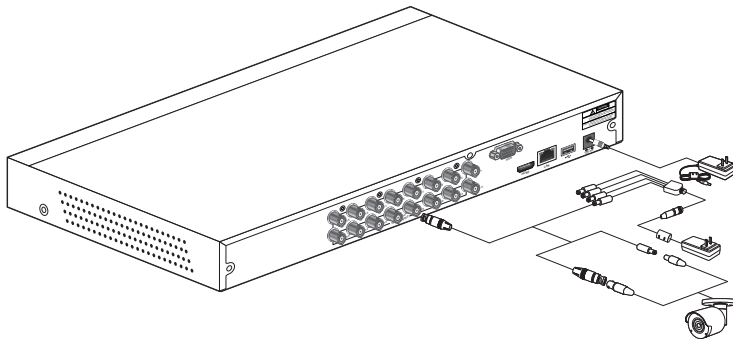

- Images may differ depending on the model.
- Camera's shape can be different depending on AIO Kit you purchased.
- Power splitter differs depending on the number of camera connected.

DVR Boot up

SYSTEM INITIALIZATION

After connecting the DVR power cable to wall outlet, the DVR system initializing screen will appear.

- It may take 40 seconds to start up, and the screen may beep 5~6 times.



LOGIN

1. The login dialog appears.
2. The password setting window appears for the first time. If you have changed your password, enter your new password.
3. Click the [Apply] button.

- Please create a user name and password for your device. Password MUST be 8~13 characters long. When password is 8~9 characters long, it should be with at least a combination of letters, digits and special symbols. If it is 10~13 characters long, it should be with at least a combination of two types of characters. 4 or more contiguous or repeated characters or key arrangement are prohibited, for example 1111, 1234, abcd, qwerty.
- Change your password on a regular basis.

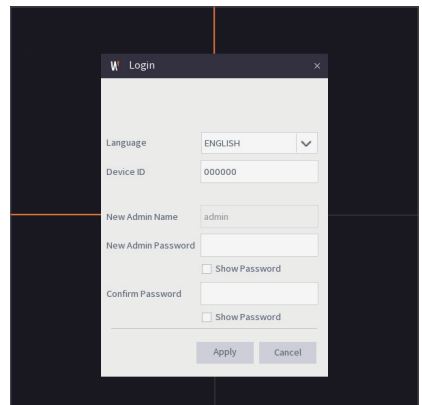

STARTUP WIZARD

After the DVR startup is complete, the startup wizard will display.

Wizard setting menu includes: Network, Date/Time, Disk, Resolution, Mobile and System summary.

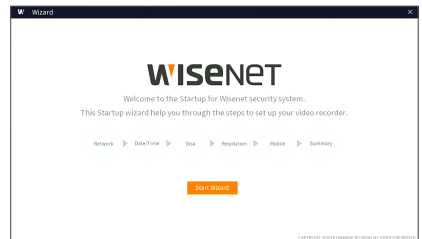

DVR Boot up

Use Virtual Keyboard



Virtual keyboard window will be displayed for input. Click on the desired characters to apply them. Press < ↑ > to switch to input of upper-case letters.

Press < ↑ > again to switch to input of special characters. The virtual keyboard is used in the same way as with physical keyboard.

For input of password, use letters and special characters other than < \ > and < " >.

1. Network (DHCP): In DHCP mode the router will automatically assign an IP address to DVR. If the DVR fails to obtain an IP address, refer to the DVR Router Guide. If the problem still cannot be resolved, contact technical support.

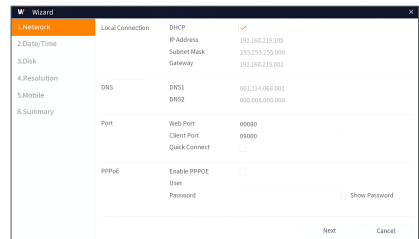

2. Date/Time: Set the date, time, date format, time, NTP, DST.

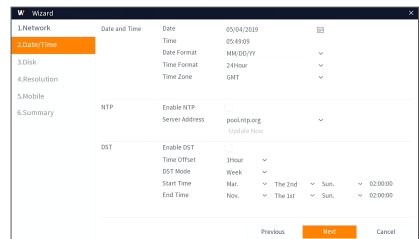

3. Disk: Any new disk connected must be formatted before use. Click on "Select" to highlight the hard drive to be formatted. Click on "Format HDD" and the user login box will appear. Enter the password to log in. Click on "OK" to format the disk when the "Entire data will be erased, do you want to continue?" dialog box appears. Formatting process is complete when the progress bar is full.

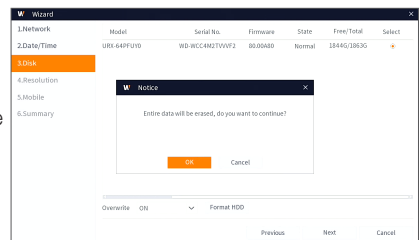

- Resolution : Select the resolution for the VGA output or HDMI output of your monitor.

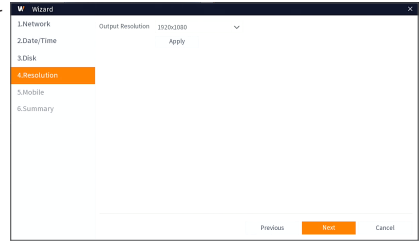

- Mobile : If you scan a QR code using Wise View, the device ID displayed in the DVR will be automatically reflected in the Mobile Viewer ID, and you can use the Mobile Viewer immediately by entering the ID/password of the DVR.

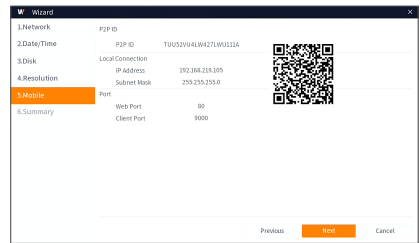

 ■ Please refer to the separate manuals for the Web and mobile viewer.

- Summary : Shows system and network status of DVR.

- Click on "**Finish**" to finish setting of startup wizard.

 ■ You can click on "**Don't show this window next time**" if you do not wish to have the wizard setting to appear next time.

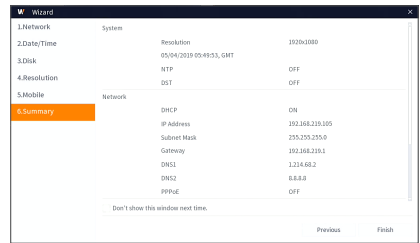

DVR Boot up

MAIN INTERFACE

In real-time preview mode: right click on any area to access the desired menu. Right click on it to open a context menu, whose menu items may vary depending on the specific condition, such as sign-in, sign-out, split screen mode and various operation conditions. Left click on any channel to access shortcut menu, where operations such as image capture, recording and image zoom-in are available.





The video recording marks are as shown below:

● : means common Recording.

👤 : means Motion detection.

Component Name	Function
1 Channel Name	Display channel name
2 Video Loss	Camera is off-line
3 Manual Recording	Enable or disable manual recording
4 Manual Capture	Make a snapshot of current video
5 Instant Playback	Playback of the last five minutes of the video
6 Zoom	Hold and drag mouse cursor to select a frame of current video to zoom in
7 Color Setting	Set hue, brightness, contrast and saturation of current channel
8 Main Menu	Access the main menu

Component Name		Function
9	4-Channel Layout	Display 4 channels of video
	9-Channel Layout	Display 9 channels of video
	12-Channel Layout	Display 12 channels of video
	16-Channel Layout	Display 16 channels of video
10	Auto SEQ	Press this button to switch the screen mode in sequence
11	Play	Replay video recorded
12	Connection state	Display the network connection status
		 connect fail : Not connected WAN.
		 not connect : Not connected physically.
		 connect success : connected WAN.
13	Manual mode	Set manual recording mode
14	System	System Information

DVR Menu

POPUP MENU

After finishing system initialization, right click the mouse on preview interface or slide the mouse to the bottom of screen to enter into Pop-up Menu. Now you could perform parameter setting and operate on Main Menu, Multi-screen, Record Search, Sequence and Brightness settings.

The options in the pop-up menu may vary slightly according to different parameter settings and application environment. The options in the menu will be explained in detail in the following chapters.

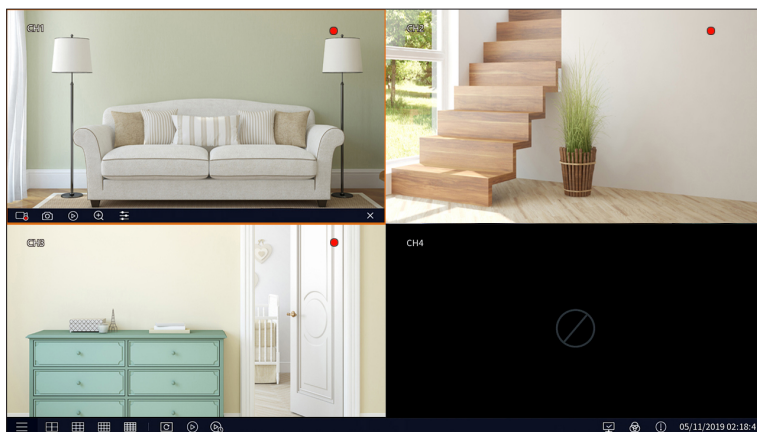

MAIN MENU GUIDE

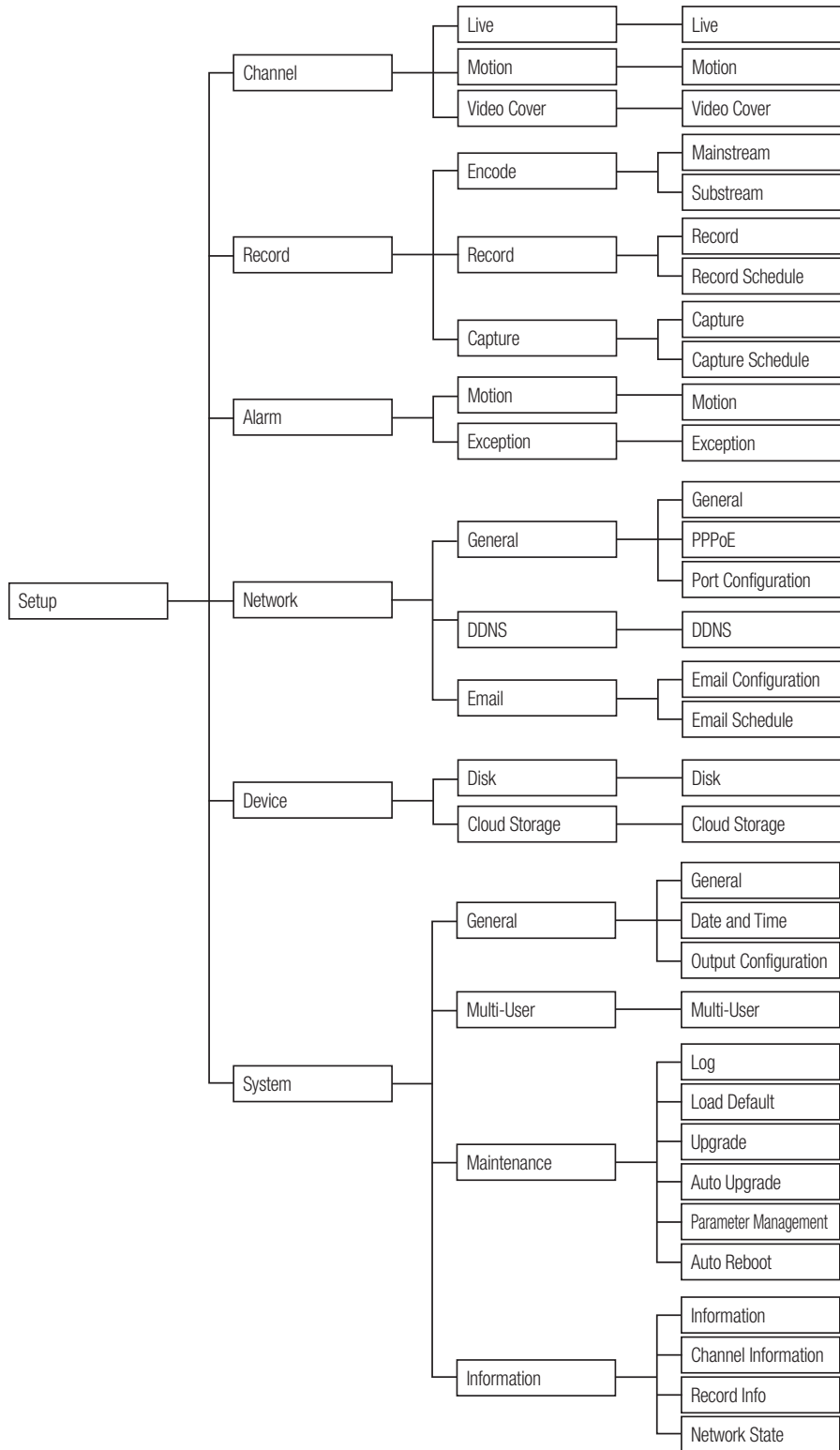

DVR Menu

SETUP

On LIVE mode, click the mouse Right button, or [Menu] button on the remote controller, and select [] icon on the toolbar to enter the main menu screen.

If system interface is locked, refer to page 32 to unlock by entering your password.

In Main Menu mode, you can make settings for Parameter, Record Search, Device, System, Advanced and Shutdown.

Channel

Live

Go to "Setup" → "Channel" → "Live" → "Live" to enter into the interface.

- **Channel** : Select the channel in the drop-down list.
- **Covert** : Enable/Disable Video hiding.
- **Channel Name** : Can be up to 40 characters in length.
- **Show Name** : Showing Channel name
- **Record Time** : Enable or disable displaying system time in recording.

- **RGB** : Adjust the chromaticity of video
- **Brightness** : Adjust the brightness of video
- **Contrast** : Adjust the contrast of video
- **Saturation** : Adjust the saturation of video

 ■ Click [] to display the detailed setting window.

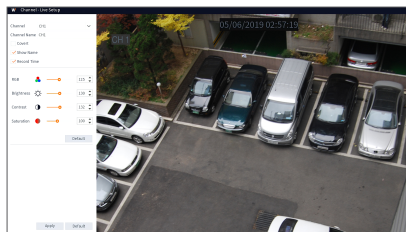
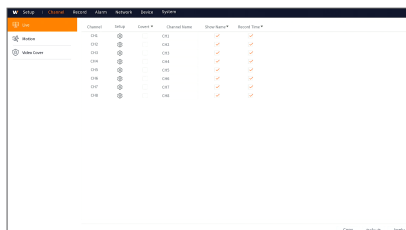

Motion

Go to "Setup" → "Channel" → "Motion" → "Motion" to enter into the interface.

- **Channel** : Select Channel.
- **Use** : You can select whether or not to use the use.
- **Sensitivity** : Support 1-8 level, 8 is the highest level.
- **Setup** : Set an area where motion is detected.

 ■ Click [] to display the detailed setting window.

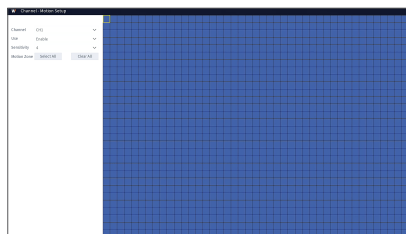
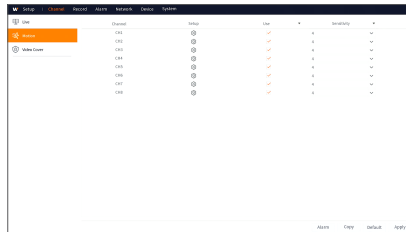

Video Cover

Go to "Setup" → "Channel" → "Video Cover" → "Video Cover".

Privacy Zone is to block certain area(s) in the camera's field of view on live video of selected channel.

1. Click "**Enable Privacy Zone**" and select the number of the Area(s) to be blocked.
2. Adjust the position and zone of the Area(s).
3. Click "**Apply**" to save the setting.

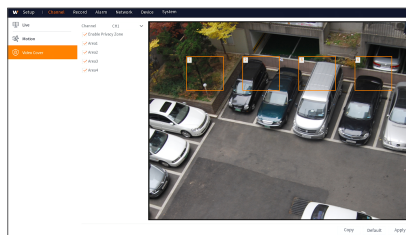

DVR Menu

Record

Encode

Go to "Setup" → "Record" → "Encode" → "Mainstream" or "Substream" to enter into the interface.

Mainstream

- **Resolution** : 960x480 / 1280x720 / 1920x1080
- **FPS** : 1-15FPS
- **Bitrate Control** : Select either constant (CBR) / variable (VBR) bitrate.
- **Video Quality** : When bitrate control to set VBR, the video quality options appear. Select the desired video quality (Worst / Worse / Bad / Good / Better / Best).
- **Bitrate Mode** : Select default/custom bitrate.
- **Bitrate** : Bitrate setting.
- **Encode FPS** : For the frame rate for video-recording, the higher the frame rate is, the smoother the playback performance will be.

The specific parameters between Encode FPS and Live View are:

NTSC		PAL	
Encode fps	Live fps	Encode fps	Live fps
10	30	10	25
11	29	11	25
12	26	12	25
13	21	13	21
14	21	14	21
15	21	15	21

 ■ Encode FPS and Live View options are only supported on the SDR-74306.

Substream

- **Resolution** : 352x240
- **FPS** : 1-15FPS
- **Bitrate Control** : Select either constant (CBR) / variable (VBR) bitrate.
- **Video Quality** : When bitrate control to set VBR, the video quality options appear. Select the desired video quality (Worst / Worse / Bad / Good / Better / Best).
- **Bitrate Mode** : Select default/custom bitrate.
- **Bitrate** : Bitrate setting.

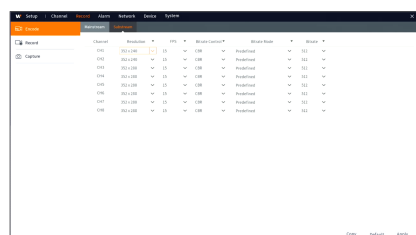
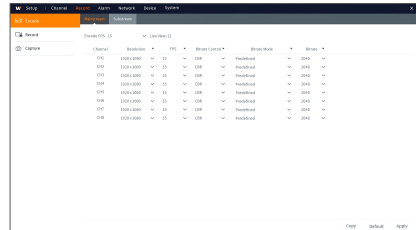

Record

Go to "Setup" → "Record" → "Record" → "Record" to enter into the interface.

- **Record** : ON/OFF record.

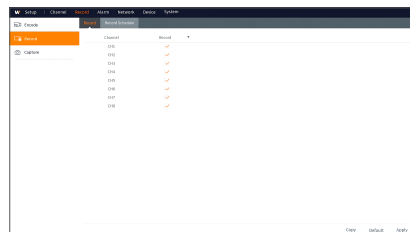

Record Schedule

Go to "Setup" → "Record" → "Record" → "Record Schedule" to enter recording schedule for the DVR.

Schedule interface

Select the channel and the date to be set.

One week's schedule can be set.

The record schedule of the current channel can be copied to any other channel or all channels.

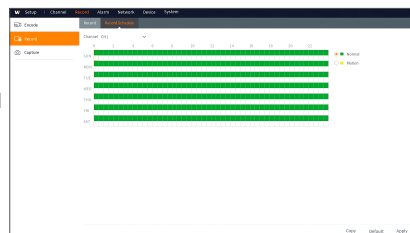

- In the Record menu and Record Search menu, when no colors are presented, it means there are no recordings during that time;
- "Green" stands for normal record and "yellow" stands for motion record.

Capture

Go to "Setup" → "Record" → "Capture" → "Capture".

- **Enable Capture** : ON/OFF auto capture.
- **Stream Type** : Select MainStream or SubStream.
- **Interval** : 4s / 8s / 25s / 1Min / 10Min / 30Min / 1Hour.
- **Manual Capture** : ON/OFF manual capture.

- You can click on the icon [📷] in the live window to manually capture the image with your mouse.

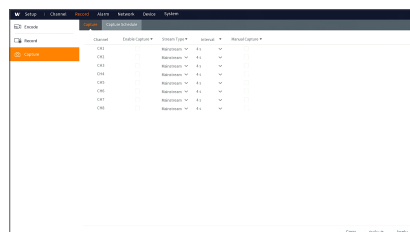

Capture Schedule

Go to "Setup" → "Record" → "Capture" → "Capture Schedule".

- **Normal** : Conventional capture setting
- **Motion** : Motion detect capture setting

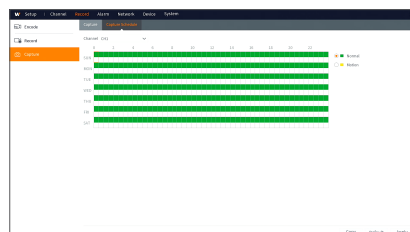

DVR Menu

Alarm

Motion

Go to "Setup" → "Alarm" → "Motion" → "Motion" to enter into the interface.

- **Buzzer** : When detecting object moving, buzzer makes alarms (disable, 10 seconds, 20 seconds, 40 seconds and 60 seconds).
- **Record** : When object motion is detected, the record channel setting will be activated.
- **Post Recording** : After the alarm finishes, the duration time of the alarm recording can be set as 30 seconds, 1 minute, 2 minutes and 5 minutes.
- **Show Message** : Messages will be displayed on the screen when moving object is detected and alarms are made.
- **Send Email** : When moving object is detected, send Email to the specified Email address.
- **Full Screen** : If motion is detected, the channel where the motion occurred is changed to a full screen view.

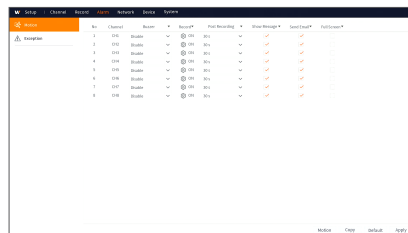

Exception

Go to "Setup" → "Alarm" → "Exception" → "Exception" to enter recording schedule for the DVR.

- **Event Type** : Support three abnormal types: No Space on Disk, Disk Error and Video Loss.
 - No Space on Disk : When camera detects object moving, alarm will be activated.
 - Disk Error : Alarm will appear when the HDD does not work due to damage, power failure, HDD auto-overwrite off and insufficient space.
 - Video Loss : When the DVR fails to receive video signals due to some problems (camera damage, power failure), the alarm will appear.
- **Use** : Active alarms for abnormal situations.
- **Buzzer** : How long the buzzer will sound (10s, 20s, 40s, 60s).
- **Show Message** : You can set show message on the screen when alarm is detected.
- **Send Email** : Select to send Email to specified Email address when abnormal events appear.

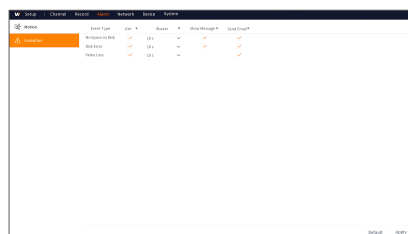

Network

General

Go to "Setup" → "Network" → "General" → "General" to enter the interface.

Select the network connection option (PPPoE, DHCP, Static) to set the port. User can view and do the recording, playback or backup of the video remotely.

Take DHCP as an example. In this mode, the router automatically assigns IP address for the DVR. After restarting the DVR or DHCP server, the IP address obtained by the DVR may be different. As a result, you need to check the IP address and port numbers before remote access to the DVR every time. The operation procedure is as follows:

1. Select DHCP, click Apply and restart the DVR. Input Client Port and Web Port (the two ports must be different).

For PPPoE, Static and DHCP, after setting the IP address for the DVR, the extranet port shall be mapped in the router before visiting DVR through public network.



- Save the setting to apply the changes made. If there are multiple DVRs in a LAN, make sure their IP addresses are different.

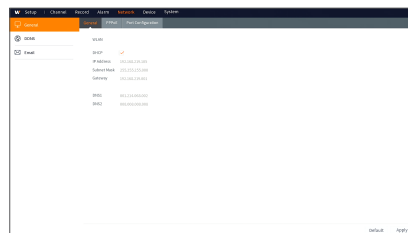

Port Configuration

Go to "Setup" → "Network" → "General" → "Port Configuration" to enter the interface.

- **Web Port:** This is the port that you will use to log in remotely to the DVR (e.g. using the Web Client). If the default port 80 is already taken by other applications. Please change it. http://Public network IP: Web port number (such as 80)
- **Client Port:** This is the port that the DVR will use to send information through. If the default port 9000 is already taken by other applications, please change it.
- **Quick Connect:** If you want to log in remotely (WAN) to the DVR using Web Client, you need to complete the port forwarding. Enable this option if your router supports the Quick Connect. You need to enable Quick Connect both, on DVR and router. In this case, you do not need to configure manually port forwarding on your router. If your router does not support Quick Connect, make sure the port forwarding is completed manually. (Web port and Client port)

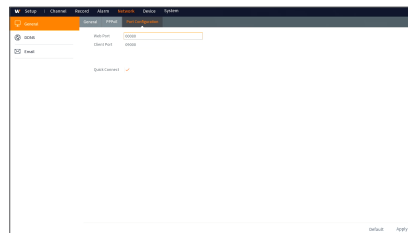

DDNS

Go to "Setup" → "Network" → "DDNS" → "DDNS" to enter into the menu interface.

User may set DDNS in any one of the above 3 network connection types after applying dynamic domain service. User may remotely access the DVR through domain by using User may remotely access the DVR through domain by using CMS. When using DDNS domain name to access the DVR, user must confirm that the port can be normally connected to current IP on the public network and the settings for server address/host name/user/password/setting should be consistent with the DVR local setting.

- **Server :** Select dynamic domain name server provider. Available domain name servers (HANWHA-SECURITY, DDNS_3322, DYNDNS, NO_IP, CHANGEIP, DNSEXIT)
- **Domain:** dynamic domain name of the host obtained from dynamic domain name service provider upon registration, for example, http://ddns.hanwha-security.com/snb5000
- **User(Product ID) :** The user name registered upon application for dynamic domain name.
- **Password:** The password set upon registration.
Click on "Test DDNS". If connection succeeds, it will be indicated that "DDNS Test is Successful!"

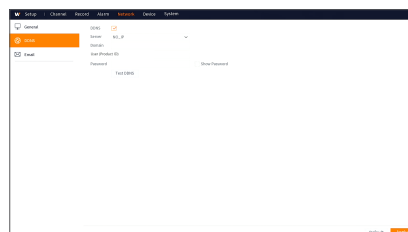

REGISTERING WITH DDNS

To register your product with the Wisenet DDNS

1. Visit the Wisenet DDNS web site (<http://ddns.harwha-security.com>) and sign in with a registered account.

2. From the top menu bar, select <MY DDNS>.



3. Click the [Register Product] tab.

4. Select DDNS button.

5. Enter the product ID.

6. Select a <Type> and specify the <Model>.

7. Specify the product location with a description if necessary.

8. Click [Product Registration].

The product will be added to the product list that you can check.

No.	Product ID	Model	Connection Status	Product Management	View	Video Tagging
1	HW1234		OFF	[Edit] [Delete]	[View]	
2	HW56789		OFF	[Edit] [Delete]	[View]	

E-mail

Go to "Setup" → "Network" → "Email" → "Email Configuration" to enter into the menu interface. Receive or Send DVR alarm Email and set parameters like Email address, SSL, Email Enable, and Interval.

- **Encryption:** Disable, SSL, TLS and Auto optional. Auto means it can detect the encryption type automatically. It is recommended to set the encryption type as Auto.
- **SMTP Port:** Mail sending port used by SMTP (Simple Mail Transfer Protocol). Server is generally Port 25 or Port 465 when SSL is used by Gmail.
- **SMTP Server:** Enter the address of the server for the mailbox in use.
- **User Name:** Enter a server to connect to. For example, email "aaa@gmail.com" should correspond to server "smtp.gmail.com"
- **Password:** Enter the password of the SMTP server user.
- **Sender:** Sender's mail address, which must correspond to the server used. For example, mailbox "aaa@gmail.com" should correspond to server "smtp.gmail.com".
- **Receiver 1/2/3:** Recipient's mail address, used to receive alarm image and message from DVR side. If system alarms continually and sends email images frequently, save the images to another location or remove them, so as to avoid excessive space occupation and thereby affect your normal use of mailbox.
- **Interval:** A mail will be sent every three minutes by default. If the time interval for mail notification is set too short, email server may deem mails as junk mails, so they cannot be transferred normally.

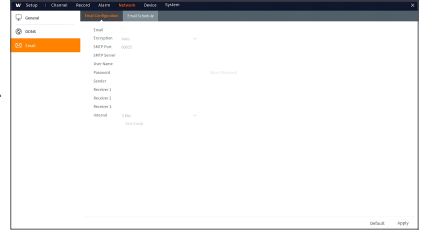

Mailbox Setting:

For example, if you are using Gmail, sign in to the GMAIL mailbox. <https://mail.google.com>

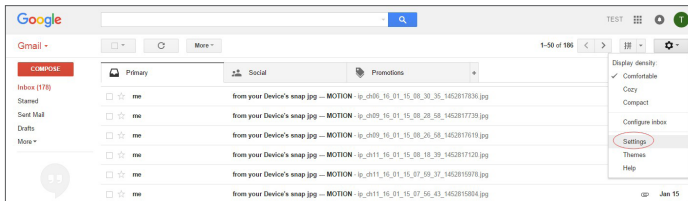

DVR Menu

Click on "settings--Forwarding and POP/IMAP"

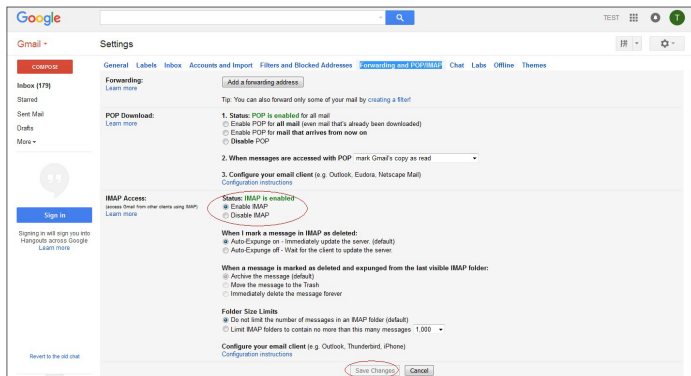

Click on "Enable IMAP--Save Changes"

E-mail Schedule

Go to "Setup" → "Network" → "Email" → "Email Schedule" to make Email schedule.

Select the channel and the date to be set.

One week's schedule can be set.

The record schedule of the current channel can be copied to any other channel or all channels.

-  Blue stands for Motion: Email will be sent in case of object motion;
- Green stands for System: Email will be sent in case of System, e.g. No Space on Disk, Disk Error, Video loss, etc.

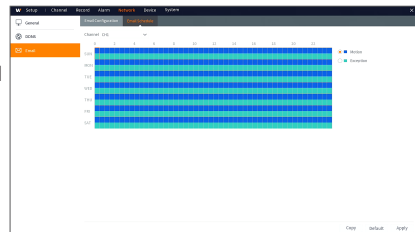

Device

Disk

Go to "Setup" → "Device" → "Disk" to enter into the interface.

When HDD is connected, the system will automatically detect if the HDD is OK or not; if the HDD needs to be formatted, select the HDD and format it. If the system detects the HDD is OK, the HDD status will be shown as "Normal".

- **No.** : Number of HDD connected to system.
- **Model** : Displays HDD model name.
- **Serial NO.** : Displays the HDD serial number.
- **Firmware** : Displays the HDD firmware version.
- **State** : It shows the current status of the HDD. It will be available only when the HDD is "Normal".
- **Free/Total** : Remaining or total space of the HDD
- **Overwrite** : When set to ON and the hard drive is full, the DVR will overwrite the oldest files on the hard drive. When set to OFF and the hard drive is full, the DVR will stop recording.
- **Format HDD** : Format HDD for the first use.

 ■ Recording can only be performed when the HDD is in "Normal" state.

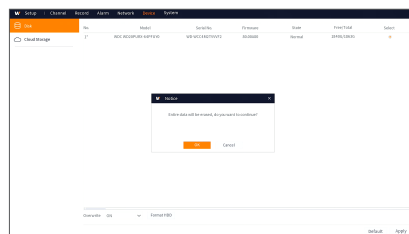
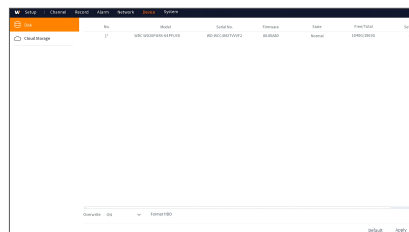

Cloud Storage

Cloud Storage

- **Cloud** : It can upload the captured pictures to Dropbox at normal time, or when motion detection happens.
 - 1) To use the cloud backup, you need to register your email first. For the detail, please refer to the page 23.
 - 2) Register an account on <https://www.dropbox.com/>.
 - 3) Configure network to ensure DVR is under network.
 - 4) Configure Cloud: Enable Cloud and set the channel. Enable Motion Detection to have it capture pictures when motion detection happens.
 - 5) Driver Name refers to the name created in the folder of Dropbox and the name can be defined by the user, e.g. CloudDVR000. The folder is to store captured pictures from the DVR.
 - 6) Click [Activate Cloud] to activate Cloud and Email for the user verification will be sent. Click the link in the email and then log in to your dropbox account, and click permit. DVR cloud storage function will be activated. If you have logged in your dropbox account before Cloud storage activation, then no need to relogin. Just click Permit to complete the activation. Please finish the activation within 3 minutes. After activation is completed, you can use the Cloud storage function.
 - 7) Click the icon at the upper-left of dropbox account interface to view the folder made in the 5th step.
 - 8) Open the Dropbox folder to view the DVR captured pictures.

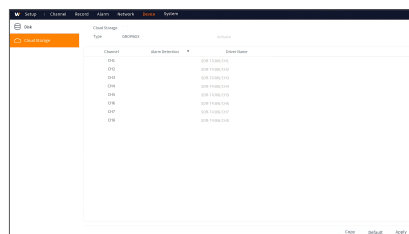

DVR Menu

System

General

Go to "Setup" → "System" → "General" → "General" to enter into the interface.

User may set Device Name, Device ID, Language, Menu Timeouts and Show Wizard on this page.

- Live restriction : If you want to use the permission setting of Live View when turning the power on/off, please check.

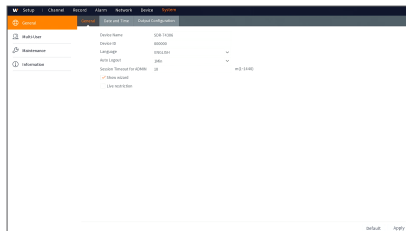

Date and Time

Go to "Setup" → "System" → "General" → "Date and Time".

Date and Time

User may set Date, Time, Date Format, Time Format and Time Zone.

NTP Settings

- **Enable NTP** : Enable/Disable NTP function.
- **Server Address** : Select NTP server (time.windows.com, time.nist.gov, pool.ntp.org, User-Defined).



- When NTP function is set to "Enable", system will calibrate the system time at every 00:07:50 and every start-up.

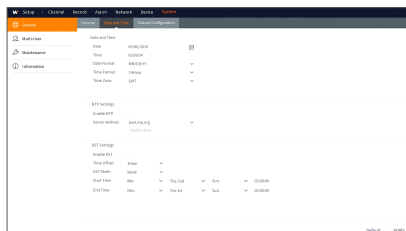

DST Settings

Enter into the interface to set DST, Time Offset, Start Time and End Time.

Output Configuration

Go to "Setup" → "System" → "General" → "Output Configuration" to enter into the interface.

- **Video Output** : Live Output
- **Seq Mode** : Sets the Layout1, 4, 8.
- **SEQ Dwell Time** : Sequence time is set 5 seconds by default. User may set it as required up to 300 seconds
- **VGA/HDMI Resolution** : For VGA output or HDMI output, the optional resolution includes.
 - VGA (1024x768, 1280x1024, 1280x720)
 - HDMI (1024x768, 1280x1024, 1280x720, 1920x1080)
- **Scale and Offset** : Sets the scale and offset.
- **Cursor Hidden Delay** : Sets the Cursor Hidden Delay time.
- **Cursor Acceleration** : Sets the cursor speed.
- **Transparency** : Adjust menu transparency in the range of 0-128.
- **Video Format** : Sets the NTSC or PAL.

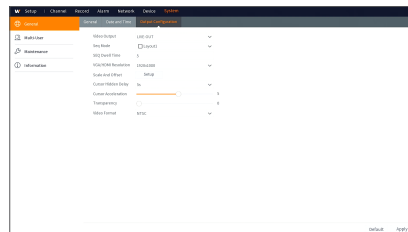

Multi-User

Go to "Setup" → "System" → "Multi-User" to enter into the User interface.

It supports up to seven users, including one administrator and six users. Click [] button to enter into the [User Edit] interface to input user name and password.

User Name consists of 8 characters. Password MUST be 8~13 characters long. When password is 8~9 characters long, it should be with at least a combination of letters, digits and special symbols. If it is 10~13 characters long, it should be with at least a combination of two types of characters. 4 or more contiguous or repeated characters or key arrangement are prohibited, for example 1111, 1234, abcd, qwerty.

Set user password. Administer is authorized to set user common user's authority.

- **Log Search** : Allow you check all the system logs.
- **Parameter** : Allow you set all the parameters.
- **Auto Reboot** : Allow you to reboot and shutdown the DVR.
- **Manual Record** : Allow you manually start/stop record.
- **Remote Login** : Allow you sequence live screens for all the channels.
- **Manual Capture** : Allow you to manually take a snapshot
- **Live** : Tick-select the ENABLE " option and select a channel and the user is allowed to view all the live images in the selected channel.
- **Playback / Backup** : Tick-select the ENABLE " option and select channel for playback/backup, the user is allowed to playback/backup the record in the selected channel.

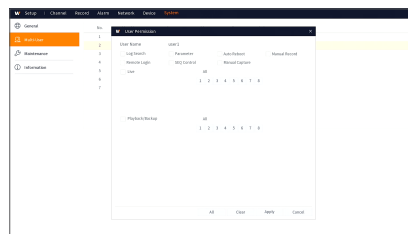
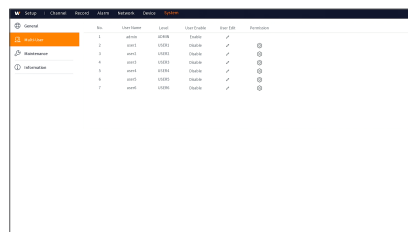

DVR Menu

User Edit

User may enable or disable the function or set password.

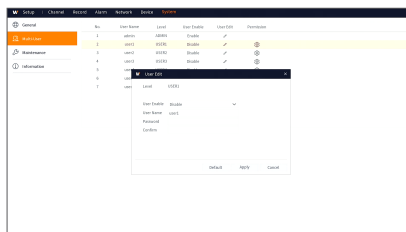

Maintenance

Log

Go to "Setup" → "System" → "Maintenance" → "Log".

User may search log information in different period of time. Click "Backup" to save all the log information.

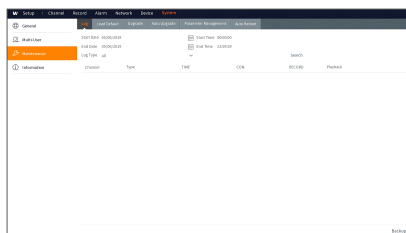

Load Default

Go to "Setup" → "System" → "Maintenance" → "Load Default" to enter into the interface.

If [Load Default] is selected, you can initialize the system to the ex-factory default. Click "Load Default" and select items to be restored. You can restore the Channel, Record, Alarm, Network, Device, System of wireless DVR to ex-factory default.

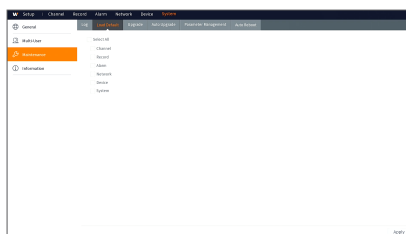

Upgrade

Go to "Setup" → "System" → "Maintenance" → "Upgrade" to enter into the interface.

Click Upgrade to enter the Device interface and select the updating file in USB to execute.

- 
 Do not take out the USB memory or cut off the power during upgrading. When the update is done, system will be automatically restarted. After about 5 minutes, the upgrading will be finished. It is recommended to load ex-factory default after upgrading.

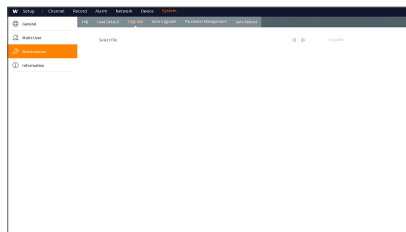

Auto Upgrade

Go to "Setup" → "System" → "Maintenance" → "Auto Upgrade" to enter into the interface.

Click Check to check if there is a newer firmware on remote network upgrade server.

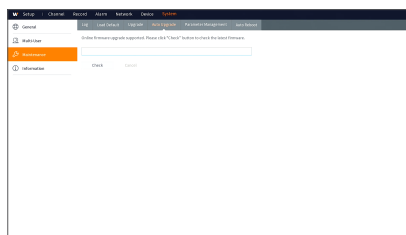

Parameter Management

Go to "Setup" → "System" → "Maintenance" → "Parameter Management" to enter into the interface.

- **Load Settings** : Load parameters in the removable storage device to DVR.
- **Save Settings** : Save the set parameters of user's DVR to the removable storage device.

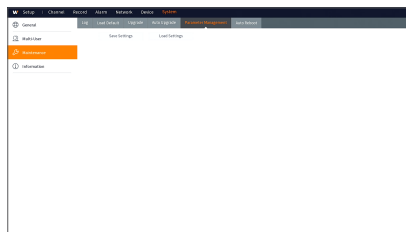

DVR Menu

Auto Reboot

Go to "Setup" → "System" → "Maintenance" → "Auto Reboot" to enter into the interface.

Enable the auto maintenance function to reboot system regularly at every day/week/month. When Auto Reboot is enabled, DVR should be in the main interface and no user operation.

-  The auto maintain function can be effective only when DVR returns back to Preview mode with no any operation within the set auto maintain time.

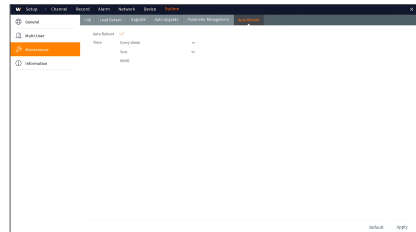

Information

Information

Go to "Setup" → "System" → "Information" → "Information" to enter into the interface.

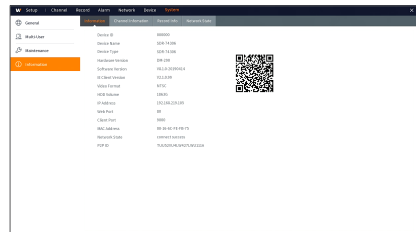

Channel Information

Go to "Setup" → "System" → "Information" → "Channel Information" to enter into the interface.

Displays the Channel Information.

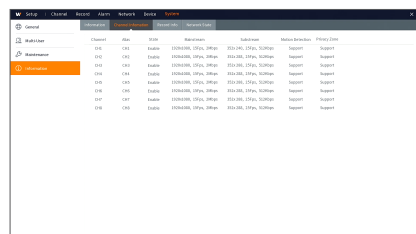

Record Information

Go to "Setup" → "System" → "Information" → "Record Info" to enter into the interface.
Displays the Record Information per channel.

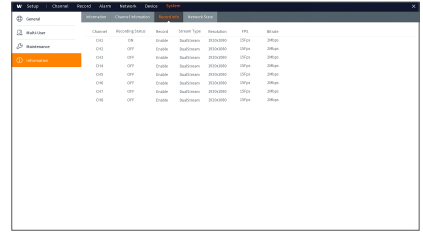

Network State

Go to "Setup" → "System" → "Information" → "Network State" to enter into the interface.
Displays the network connection status.

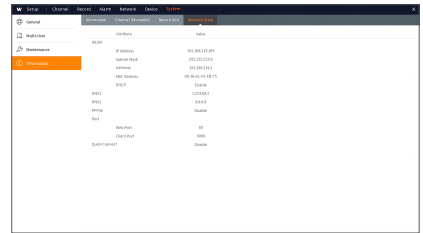

DVR Menu

SHUTDOWN

Click [] icon → "Shutdown" to enter into the interface.

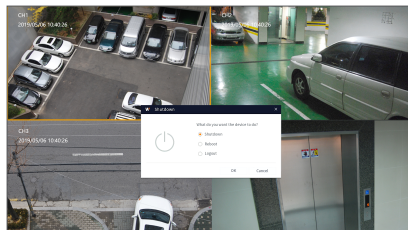

MENU LOCK

In consideration of system safety, user may click the icon [] on the toolbar when he leaves away from DVR and the system interface will be locked. User has to input Device ID, User Name and Password on the login interface to unlock. In case that the password is forgotten, contact the technical personnel.

-  Administrator has all authorization of menu operation and users have limitations for authorization and have to get authorization from administrator.

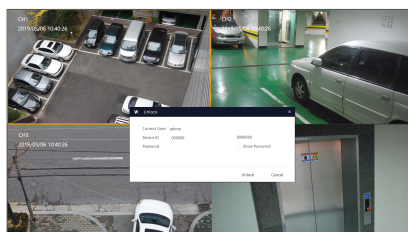

SWITCH USER

User may click the icon [] on the toolbar when change to user for DVR.

User has to input Device ID, User name, and Password on the Switch User interface to switch user.

-  The administrator must set up the user in Multi-User option. For the detail, please refer to the page 27.

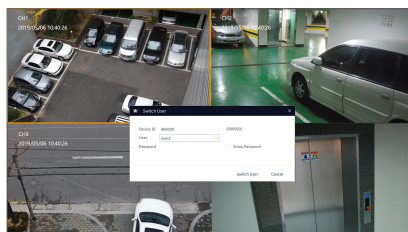

SEARCH

Click [] icon on the toolbar to enter into the Record Search interface to search and playback. Refer to former section for specific operating method.

SPLIT MODE

There are many display modes in video channel, including single channel display, SEQ display and split mode.

START SEQUENCE

After set channel sequence time, click Start Sequence icon [] on the toolbar to start sequence.

SEARCH

Record Search

General

Go to "Search" → "General" to enter into the interface.

- **Channel:** Select the channel you want to search.
- **Search Type:** Select the type the playback record. There are three options: All, Normal and Motion.
- **Playback Channel:** Click a date and select corresponding channel in Playback Channel.
 - 4CH : Max. 4CH
 - 8CH : Max. 4CH
 - 16CH : Max. 16CH
- **Playback interface:** You can use the Playback Control bar to operate the Fast Forward (X2, X4, and X8), Rewind (X2, X4, and X8), Slow play (1/2, 1/4, and 1/8 speed), Play, Pause/Frame. When playback ends, DVR will remain in the playback interface.

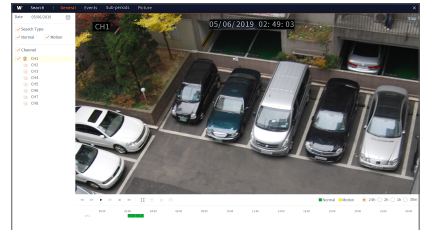

Time Axis setup, file clip and zoom in/out

The DVR supports the processing control bar function when playing back record files.

- **Time Axis zoom:** Default value is 24hours. Allow user to select 2 hours, 1 hour, 30 minutes or user-defined.

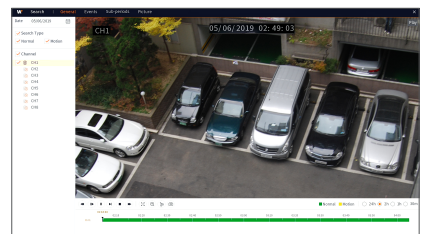
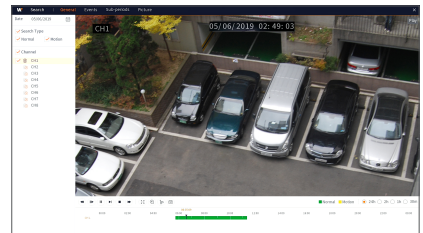

Search

- **Detailed Operation**

Fixed time axis: If you select [2h] option, that means the processing control bar covers two hour of video content. The time range refers to 1 hour before and after the middle point.

- **Clip and backup:** When it is playback, the [] icon will appear in the Play Control bar. Click the icon to start video clip function, click the icon again to end the function and pop up the dialog. Now, you may save the clipped video file.

- **Zoom out:** When it is under single channel playback, the [] icon will appear in the Play Control bar. Click the icon to zoom in certain area of the playback screen and right click mouse to return the Playback page.

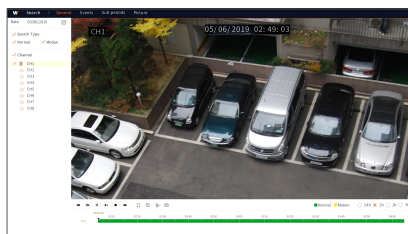

Events

Go to "Search" → "Events" to enter into the interface.

In this page, user may search details by date, time, channel and record type. The relevant operations are as follows:

<< Previous page : Click the button to go to previous page when viewing events (except the first page). When viewing the first page, click this button to display the event list in the first page.

>> Next page : Click the button to go to next page when viewing events (except the last page). When viewing the last page, click this button to display the event list in the last page.

1 2 Jump : If you click on a number, you will move to that number's page.

Two types of backup: Quick Backup and Backup

If you want to back up a record in the detailed file list, you may check the checkbox at the left of the record ("√" means it has been selected) and click "Backup" to enter into "Select backup type" (Make sure USB flash drive or other portable storage device are connected).

If you want to back up with USB, select USB and click OK to start processing and you will see the backup progress.

After backup finishes, message Backup Finishes will appear at down-right corner.

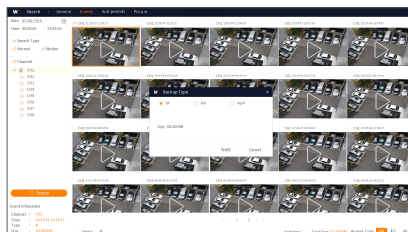
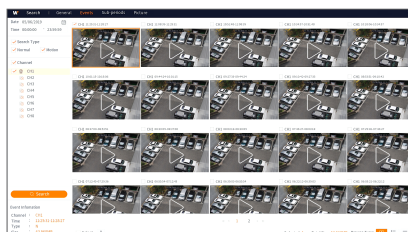

 ■ Before backup, connect devices for backup (USB flash).

Play Backup Files

1. Copy backup files to the computer.
 2. Open SVideo player and click [+] or [Open File ▾].
For example, if you want to choose *.RF, *.avi, *.mp4, add backup file and select a file to play.
- Play: Click to play file
 - Pause: Click to pause.
 - Stop: Click to stop playback.
 - Frame Forward: step forward by frame
 - Slow Play: Click to play at 1/2, 1/4, 1/8, 1/16 speed.
 - Fast forward: Click to play at 16x, 8x, 4x, 2x speed.
 - Open file/Open Directory
 - Expand/pack up the list.
 - Screenshot: Save path: C:\Users\Administrator\SVideoPlayer\picture
 - Cut: Save path: C:\Users\Administrator\SVideoPlayer\video
 - Full screen display
 - Never on top
 - Always on top
 - On top during playing
 - Window Division
 - 1/4/9/16 channels optional.
 - Add folder or file.
 - Playback mode, Single, Order, Repeat one, Repeat ALL are optional
 - Delete all files in the list.
 - Search File
 - Language/Settings

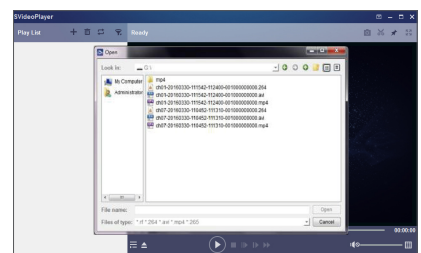
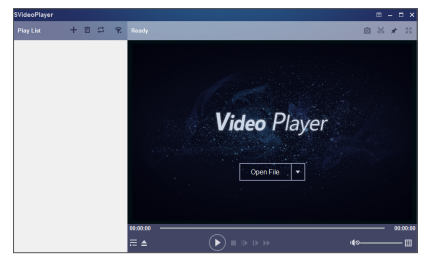

Basic Settings: Set on-top mode

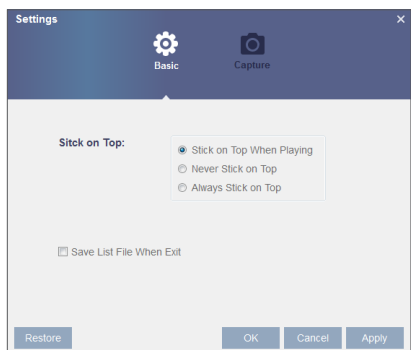

Search

Capture Settings: Set the path to save image

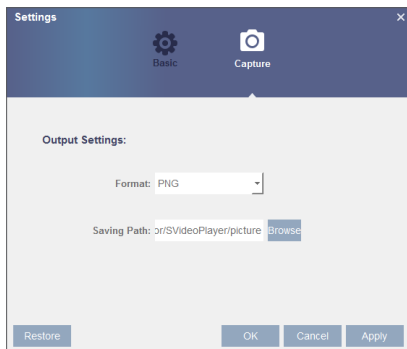

- It is recommended to use SVideo Player contained in compact disk for playback. Use of any other player may cause compatibility problem.

Sub-periods

Go to "Search" → "Sub-periods" to enter into the interface.

Sub-periods playback allows you to play multiple normal recordings and motion events simultaneously from a single channel. With normal and event recordings, the video is divided evenly depending on the split-screen mode that has been selected. For example, if the video is an hour long and you have selected Splitscreens x 4, each split-screen will play for 15 minutes.

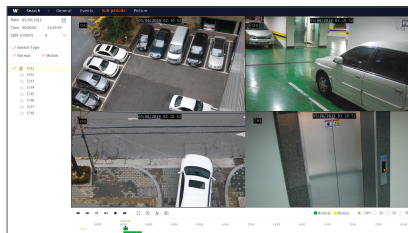

Picture

Go to "Search" → "Picture".

Support search picture for 5000pcs each time. If the picture number greater than this value, please adjust the date (time) of the current search and search again.

In this page, user may search details by date, time, channel and record type. The relevant operations are as follows:

- « Previous page: Click the button to go to previous page when viewing events (except the first page). When viewing the first page, click this button to display the event list in the first page.
- » Next page: Click the button to go to next page when viewing events (except the last page). When viewing the last page, click this button to display the event list in the last page.
- 1 2 Jump: If you click on a number, you will move to that number's page.

Two types of backup: Quick Backup and Backup

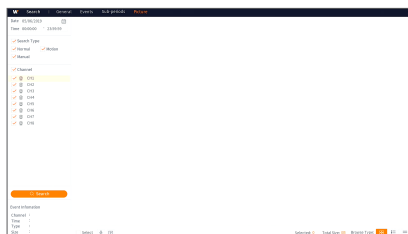

SYSTEM ENVIRONMENT REQUIREMENTS

The minimum requirements for hardware and OS required to run Web Application are given below.

	Minimum	Recommended
CPU	Intel i3	Intel i7 or higher
RAM	4GB or more	8GB or more
Hard Drive	500GB or more	1000GB or more
Display RAM	2GB or more	4GB or more
Display Resolution	1280x1024	1920x1080
OS	<ul style="list-style-type: none"> - PC : Windows® 7, Windows® 8.1, Windows® 10, Mac OS X® 10.13.5 or lower - Mobile : Android Ver 6.0 or higher, iOS 11.4.1 or higher - Supported Browser : Microsoft Internet Explorer (Ver. 11, 10, 9, 8), Mozilla Firefox Ver 51.x or lower, Google Chrome Ver 44.x or lower, Safari®11.1.1 or lower 	
DirectX	DirectX 11	
Direct3D	Acceleration Function	
Ethernet Adapter	10/100M Ethernet Adapter	
IE	Microsoft Internet Explorer (Ver. 11, 10, 9, 8)	

WISENET CLIENT Download and Installation

If your computer system is Windows 7, you may need to setup the user authority for remote control, or you may be unable to backup or record.

Vista System: Start → Setup → Control Panel. Set user authority in control panel as the following picture. Remove the Tick "√" in front of the option "Use UAC to help protect your computer" and confirm OK.

WIN7

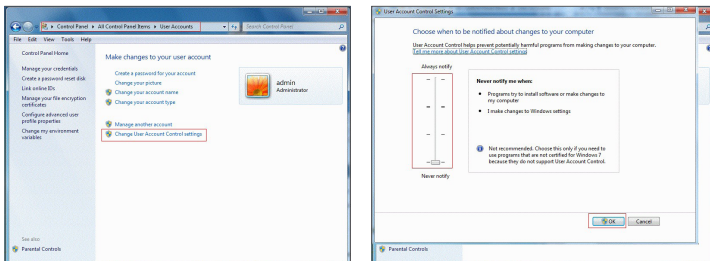

Vista

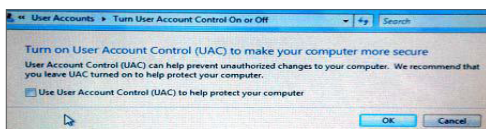

Wisenet Client / Web

- ✎ If the plugins is not downloaded successfully, please check if your browser's safety level or firewall setting is set too high. Please open IE browser → [Menu Bar] Tools → Internet options → Security → Internet → Custom level → Enable the options.

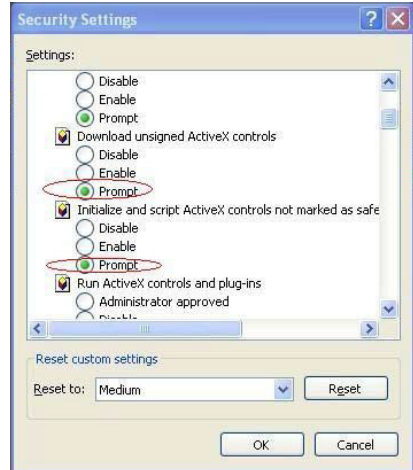

Download and installation of WISENET CLIENT for IE

1. Click to run the WISENET CLIENT program from the CD or from the user PC.
2. When the program opens, click the [Next >] button.

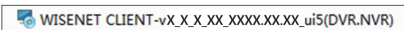

3. Click on "Install" in the dialog box "WISENET CLIENT Setup".

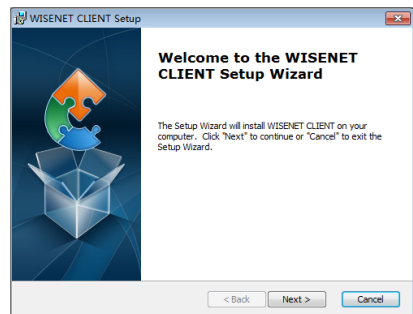

4. Upon completion, click the [Finish] button.

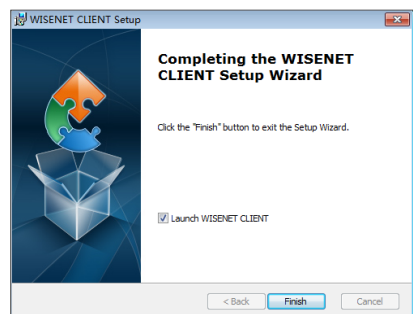
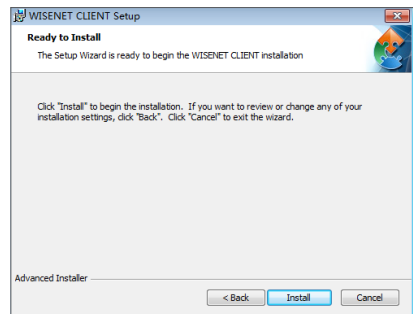

5. Shut down IE browser and restart it, and then enter IP address of DVR in address bar to access login page.

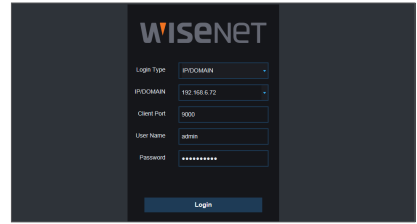

Download and installation of WISENET CLIENT for Mac SAFARI

1. Enter IP address of DVR in address bar of Mac SAFARI, for example, <http://192.168.2.173:80>, and click on "download" to download the WISENET CLIENT.

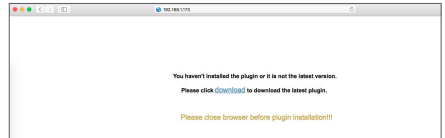

2. Locate the downloaded "WISENET CLIENT.dmg" and double click on it

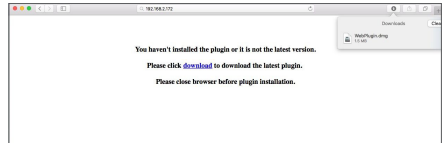

3. Install the plugin by double clicking on "WISENET CLIENT.pkg".

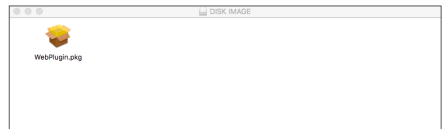

4. Click on "Continue" > "Install". Enter user name and password for login to Apple computer. Click on "Install" > "Shut down" to finish installation.

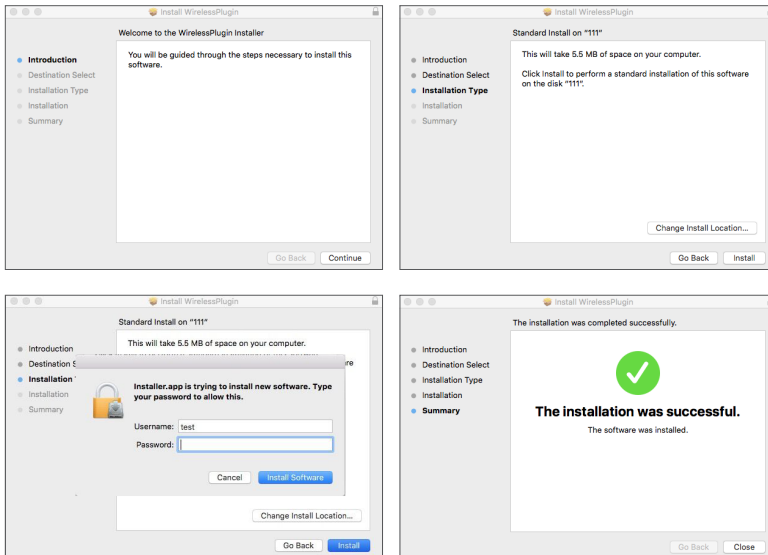

Wisenet Client / Web

5. Shut down Mac SAFARI browser and restart it, and then enter IP address of DVR in address bar to access login page.

- The above instruction is to install the initial plug in. You can use the same plugin for IE and Firefox. If plugin for windows OS was installed on IE, Firefox once, you can use IE which needs to be run as administrator, Firefox to log in to DVR.

When you download and install plugin on Firefox, please close Firefox when it is prompted to. After installation is finished, you can restart Firefox to log in to the DVR.

When you do a firmware upgrade, please close the browsers in order to have the new plug in replace the old one. Depending on your situation, the plugin may not be work on your browser. In this case, please install the plugin unavailable on the CD provided. (Web_plugin_Windows_YYYY_MM_DD.exe for Windows system, and WebPlugin_Mac_YYYY_MM_DD.dmg for Mac).

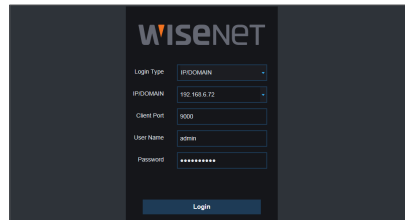

WISENET CLIENT LOGIN

After plugins installation, please input user name and password, select Main Stream or Sub Stream (In general, select main stream for intranet and sub stream for extranet), and input Client port number. There is an option for opening all channel preview, select it to open all live pictures. Press Login to log in client and remotely visit DVR. The default password is blank and administer is authorized to modify the password. Set password as per introductions of user management in system setting.

After successfully log in, it will enter the real-time monitoring interface and connect video automatically.

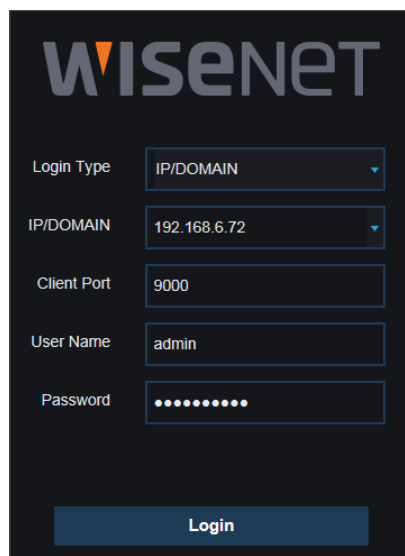

LIVE INTERFACE

Log in and enter into the live interface.

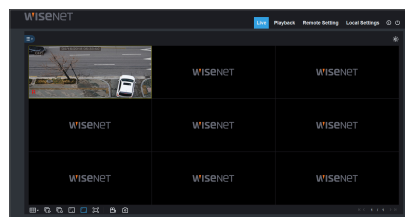

Menu Bar

Menu Bar: Live, Playback, Remote Setting, Local Setting and Logout.

Live Display Video Control

Log in the Wisenet Client, system will be defaulted to enter into <Live> interface. You can click [Play] button to Open/close live images, on-spot record, capture, and many live display modes.

Buttons on a single live interface

Channel List : Open the channel list for quick camera function.

Click [] button to display the Channel List.

Click [] button to hide the Channel List.

Live Video Stream Options:

- **Mainstream**: View all live videos using high-quality mainstream video settings.
- **Substream**: View all live videos using middle-quality substream video settings.
- **Mobile Stream**: View all live video using lower-quality mobile stream video settings to conserve bandwidth. Available for IP channels only.

 : Open or close the images on Live window.

 : Click to select how many channels appear on screen at a time.

 : Open the video on Live window.

 : Close all the Live channels

 : Shows the playing video at the original proportions.

 : Stretch the playing video to fit the full area for each channel on screen.

 : Click to maximize the current window to full screen. Right click to popup menu option and select Exit Full Screen.

 : Record switch: the remote record switch of client. Record will be automatically saved to a specified position on PC after the function is enabled.

 : Capture the selected live image and save it to a specified position on PC. The image is saved as *.bmp format.

Video Control

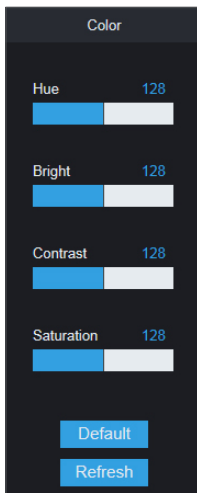

Hue: Adjust the chromaticity of video

Bright: Adjust the brightness of video

Contrast: Adjust the contrast of video

Saturation: Adjust the saturation of video

Wisenet Client / Web

Playback

Click [**Playback**] to enter into Playback interface to remotely view the records in DVR HDD.

It supports 1 to 4 channel record playback.

The recording performance (fps) of the DVR temporarily decreases while the recorded video is being played back.

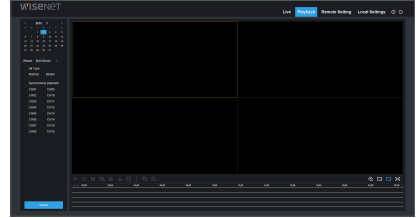

Record Search

Record playback procedure

Firstly, select the date you want to check and tick 1 to 4 channels. Any record files in current channel at current date will be displayed in the status bar of the interface.

Secondly, select record type (Normal record, Motion and All) and channels, and then click [**Search**], and time axis panel will display specific time quantum.

On the time axis, red part stands for Motion, yellow stands for normal record and original part stands for no record during this period.

Before playback, choose to enable playback 4 channels synchronously.

If you tick-select [**Synchronous playback**], that means the selected channel will playback synchronously; otherwise, you could separately control the channels playback. You can not play back frame by frame during synchronous playback.

Thirdly, start playback.

Click [**▶**] to start record playback. When mouse cursor is moving on the time axis, the time point of current position will be displayed on the time axis screen. Click to locate the record.

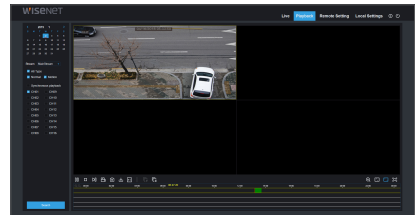

Playback Control

Playback control bar

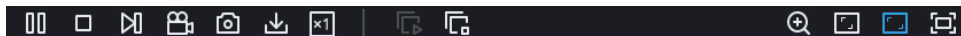

Detailed brief description is shown as below:

Key	Description	Key	Description
	Play		Slow playing x1/2, 1/4, 1/8, Fast Forward x1/2/4/8
	Pause		Open all the playback channels
	Stop		Stop playing all the playback
	Frame by frame		Digital ZOOM
	Record Clip		Original proportions
	Image Snapshot		Stretch
	Download		Full Screen

Record file clip

After opening playback, click [] icon to clip the selected file; and click again to stop the clip function. Then playback clip is successfully done. Record clip file can be saved as H.264, AVI or MP4. H.264 is set as default.

Snapshot function

Move the mouse cursor to the channel you want to capture, and click [] icon to capture the live images remotely. After capturing the images successfully, a path prompt box will be popped up.

The captured file will be saved as .bmp format.

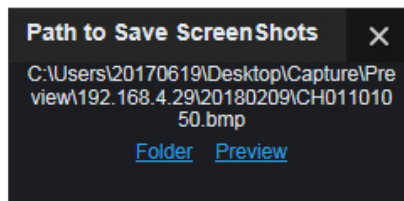

Record file download

Click download icon [] on the control bar to display all the matched record file according to the search conditions of channels.

Tick-select the record file you want to download and click [Start download]. System will download the record file in sequence and save to local PC. The downloading file will be displayed in percentage form. After downloading finishes, "Complete" will be displayed on the status bar.

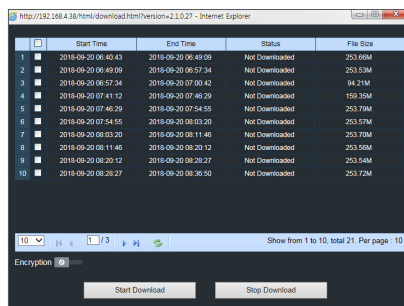

Wisenet Client / Web

Remote Setting

Click Remote Setting to enter into the interface shown, including Display, Record, Alarm, Network, Device and System.

Display

When you click the <Display> option, sub-options of Display Settings and Schedule are displayed.

Live

Displays the currently playing live screen.

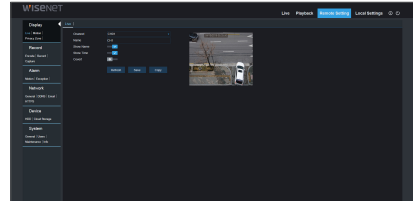

Motion

You can set the Motion area.

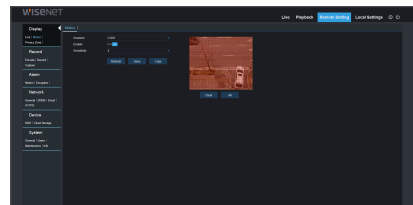

Privacy Zone

You can set the Privacy Zone.

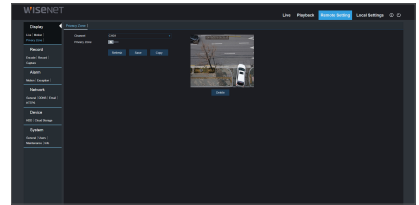

Record

Click <Record> option to unfold its sub-options: Record parameter and Schedule.

Encode

This menu allows you to configure the recording video or network transmission picture quality.

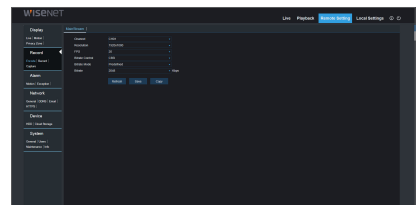

Record

Record Parameters

The parameters should be consistent with DVR local setting.

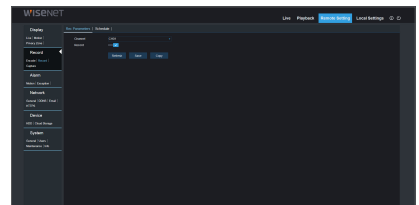

Wisenet Client / Web

Record Schedule

The parameters should be consistent with DVR local setting.
Green stands for Normal record; Yellow stands for Motion detection.

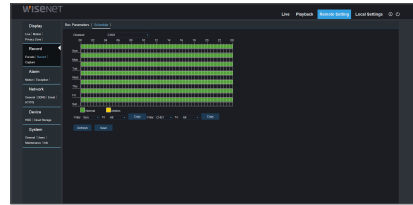

Capture

Capture

- **Channel:** Select channel.
- **Stream Type :** Select MainStream or SubStream.
- **Interval :** 4s / 8s / 25s / 1Min / 10Min / 30Min / 1Hour
- **Auto Capture:** Enable/Disable auto capture.
- **Manual Capture:** Enable/Disable manual capture.

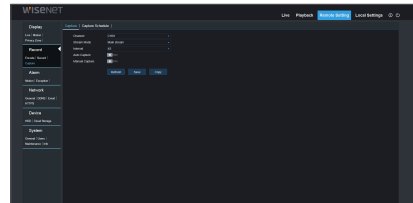

Capture Schedule

- **Channel:** Select channel.
- **Normal:** Conventional capture setting.
- **Motion:** Motion detect capture setting.

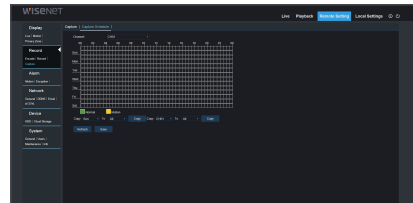

Alarm

Alarm setting includes Motion Detection Parameters.

Motion

Configure Sensitivity, Alarm out, Alarm Record and Alarm Capture, etc. Detailed setting should be consistent with DVR local setting.

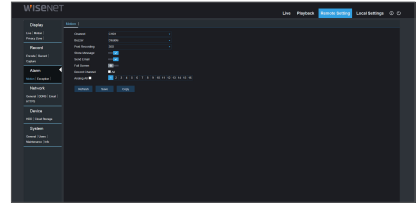

Exception

User may configure Event Type, Buzzer, Send Email, Show Message and other parameters. Detailed setting should be consistent with DVR local setting.

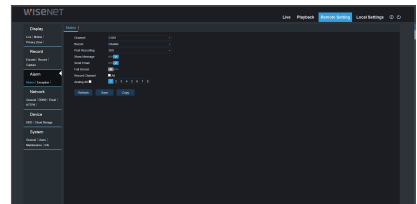

Network

Unfold <Network> to show its sub-options: Network, DDNS, and Email configuration.

General

DVR supports Static/DHCP/PPPoE modes. System default network type is <DHCP>. User can set parameters as required. If you change Network type to PPPoE, DVR will automatically restart to make the setting effective.

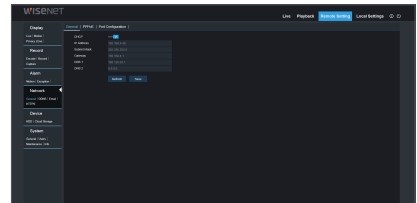

DDNS

DDNS: After user applies for DDNS service, you could enable <DDNS> function under any one network type mode (Static, DHCP and PPPoE). And you may remotely visit the DVR through domain name (http://domain name: HTTP port No.). When visiting DVR by using DDNS, user should make sure port and current IP can be normally connected in public network. Details settings, including server address, host, user, and password, should be consistent with DVR local setting.

Click on "Test DDNS". If connection succeeds, it will be indicated that "DDNS Test is Successful"

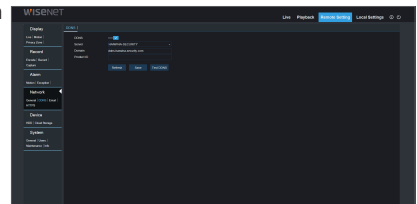

Wisenet Client / Web

Email

Email: Set DVR alarm Email configuration parameters, including Email address, Encryption, Email Enable, and Interval etc. Detailed parameters should be consistent with DVR local setting.

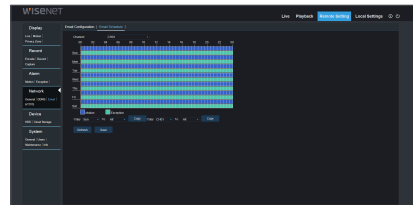
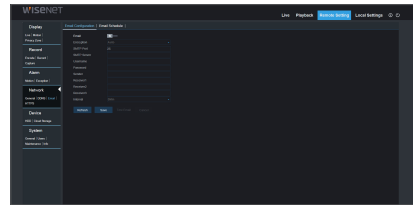

HTTPS

- Enable : Enable/Disable
- Certificate Type : Default/Custom

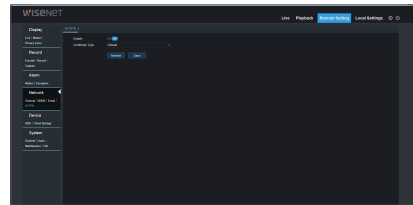

Device

Click <Device> to unfold its sub-options: HDD

HDD

User may check HDD status of DVR and overwritten time. Detail setting should be consistent with DVR local setting.

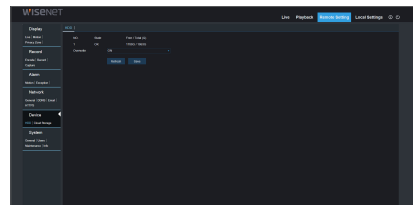

Cloud Storage

User may set the relevant parameters of Cloud Storage. Detail setting should be consistent with DVR local setting.

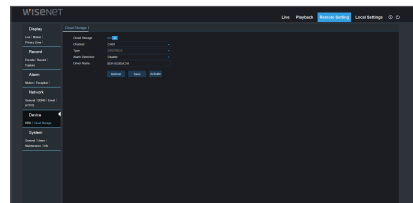

System

Click <System> option to unfold its sub-options: General, Users and Info.

General

User may check DVR language and video system and date format, menu display time, DST and NTP parameters. Detailed setting should be consistent with DVR local setting.

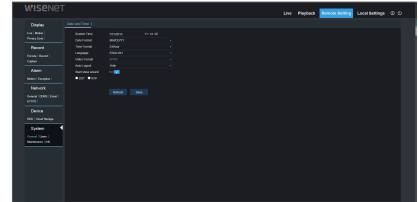

Users

User may configure user name and password and detailed setting should be consistent with DVR local setting.

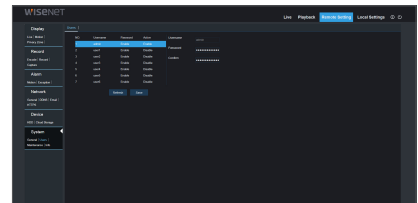

Maintenance

Load Default

User may remotely restore default parameters of DVR, with same setting method as that of DVR.

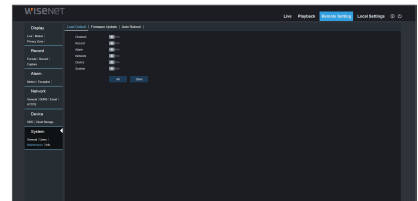

Firmware Update

User may remotely update DVR system.

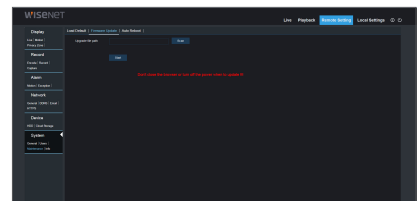

Wisenet Client / Web

Auto Reboot

Allow you remotely set auto maintain time for DVR. Detailed setting should be consistent with DVR local setting.

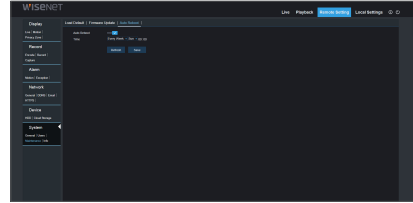

Info

Info

User may search device name, device number, device type, MAC address, software version, IE version and hardware version of DVR.

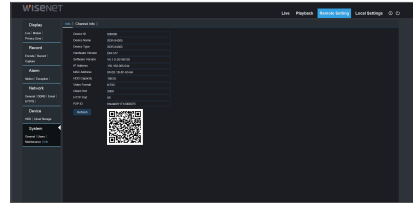

Channel Info

Displays all channels camera relevant information.

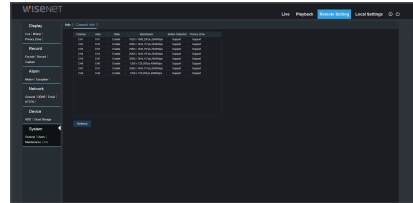

Local Setting

User may set Record Path (save Live record and Playback clip file), Download Path for remote file, Snapshot Path for captured pictures, Interval for switching record files (Packaging time), and File type (RF, AVI and MP4).

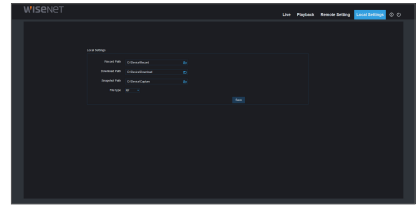

Logout

Click [] to log out and return to the login interface.

Appendix

TROUBLESHOOTING

Symptom	Countermeasures
What can I do if the system does not detect the HDD?	<ul style="list-style-type: none">• Check if the power supply system is properly connected and data cord and power cables are securely connected, and if something wrong with the HDD interface. Or you may check if your HDD is supported by referring to the specifications or descriptions.
I have changed the password but forget the new password, how can I access the system?	<ul style="list-style-type: none">• If you forget system password, please consult with our technical personnel. We strongly suggest user to set password easily to be remembered and relatively safe.
We see abnormal video signal or even no video signal by connecting the DVR and camera together. Power supply for both devices is OK. What is wrong?	<ul style="list-style-type: none">• Check network cable on DVR side to see if the cable is firmly connected and if it is worn out and needs to be replaced, or to check if NTSC or PAL is selected consistently.
How to prevent DVR from being influenced by heat?	<ul style="list-style-type: none">• The DVR needs to dissipate heat while it is running. Please place the DVR in a place with good air circulation and away from heat sources to ensure stability and life of the DVR.
The remote controller of DVR doesn't work while the monitor screen is OK and panel keys are functional. Why?	<ul style="list-style-type: none">• Operate again by aiming the remote controller at the IR receiver on front panel. If it still doesn't work, please check if the batteries in the remote controller are dying. If not, check if the remote controller is broken.
I want to take out HDD from my PC and install it in DVR. Can it work?	<ul style="list-style-type: none">• All HDDs supported by the system can be used. But remember, once DVR runs, the data on your HDD will be lost.
Can I playback while recording?	<ul style="list-style-type: none">• Yes. The system supports the function of playing while recording.
Can I clear some records on HDD of DVR?	<ul style="list-style-type: none">• In consideration of the file security, you may not clear part of records. If you want to remove all the records, you can format HDD.
Why can't I log in DVR client?	<ul style="list-style-type: none">• Please check if the network connection settings are correct and check if your account and password are correctly input.
Why can't I find any records during playback?	<ul style="list-style-type: none">• Please check if the data line connection for HDD is OK and system time is properly adjusted. Try a few times and restart. If it still doesn't work, check if the HDD is broken.
Why doesn't dynamic detection work?	<ul style="list-style-type: none">• Please check if the motion detection sensitivity level set is too low and motion detection area setting is correct.
Why does buzzer keep alarming?	<ul style="list-style-type: none">• Please check the alarm setting, check if motion detection function is enabled and object motion is detected all the time. Besides, refer to corresponding HDD alarm setting.

Usage Maintenance

1. To shut down DVR, please firstly shut down the system and then turn off the power. Do not turn off the power directly or HDD data will be lost or damaged.
2. Please keep DVR away from heat sources or places.
3. Clean the internal dust regularly. Make sure the good ventilation of DVR so as to ensure the good heat dissipation.
4. Please do not hot plugging video cable, otherwise the ports will be damaged.
5. Please check the HDD cable and data cable regularly to see if they are ageing.
6. Please prevent video signals of DVR from being intervened by other electronic devices, and prevent the HDD from being damaged by static electricity and induced voltage.
If the network cable is frequently plugged, it is suggested to replace connecting line regularly, or the input signal may be unstable.
7. This is A class product. it maybe bring wireless interference in life. Under this situation, it need user to make measures.

Appendix

SPECIFICATIONS

Item		Details		
		SDR-73306	SDR-74306	SDR-75306
Video Input	System	CVBS, AHD		
	Resolution	- 1920x1080 (1080p) - 1280x720 (720p) - 960x576 (960H)		
Live	Frame rate & Resolution	- 120fps@1920x1080 (1080p) - 120fps@1280x720 (720p) - 120fps@960x576 (960H)	- 240fps@1920x1080 (1080p) - 240fps@1280x720 (720p) - 240fps@960x576 (960H)	- 480fps@1920x1080 (1080p) - 480fps@1280x720 (720p) - 480fps@960x576 (960H)
	Multi Screen display	1/4/Seq	1/4/8/Seq	1/4/9/12/16/Seq
Performance				
Operating System		Embedded Linux		
Installation wizard		Support		
Recording	Compression	H.264		
	Resolution	- 1920x1080 - 1280x720 - 960 x 576 (960H)		
	Record Rate	Main stream - Max. 60fps@1080p - Max. 120fps@720p (with 720p camera) - Max. 120fps@960H (with 960H camera) Sub stream - Max. 60fps@CIF	Main stream - Max. 120fps@1080p - Max. 240fps@720p (with 720p camera) - Max. 240fps@960H (with 960H camera) Sub stream - Max. 120fps@CIF	Main stream - Max. 240fps@1080p - Max. 480fps@720p (use 720p cam) - Max. 480fps@960H (with 960H camera) Sub stream - Max. 240fps@CIF
	Mode	- Manual - Schedule (Continuous/Event) - Event (Pre/Post)		
	Event	- Video Loss - Motion (Sensitivity Level 1~8)		
	Overwrite modes	On (Auto), Off		
	Pre-alarm	1 ~ 10sec		
	Post-alarm	Up to 5min (10 ~ 300 sec)		

Item		Details		
		SDR-73306	SDR-74306	SDR-75306
Search & Playback	Search mode	Date/time, Event, Motion		
	Playback function	<ul style="list-style-type: none"> - Fast forward/backward (X2, X4, X8) - Slow forward (X1/2, X1/4, X1/8) - Step Forward 		
	Synchronous	4ch	8ch	16ch
	Total Performance	<ul style="list-style-type: none"> - Max. 60fps@1080p - Max. 120fps@720p (with 720p camera) - Max. 120fps@960H (with 960H camera) 	<ul style="list-style-type: none"> - Max. 120fps@1080p - Max. 240fps@720p (with 720p camera) - Max. 240fps@960H (with 960H camera) 	<ul style="list-style-type: none"> - Max. 240fps@1080p - Max. 480fps@720p (with 720p camera) - Max. 480fps@960H (with 960H camera)
Network	Stream	128Kbps~4096Kbps		
	Transmission speed	Max.60fps@1080p	Max.96fps@1080p	Max.240fps@1080p
	Transmission Bandwidth	32Mbps	32Mbps	64Mbps
	Protocol support	TCP/IP, RTP(TCP), RTSP, NTP, HTTP, DHCP(Server, Client), PPPoE, SMTP, DNS, DDNS (Hanwha DDNS), uPnP, HTTPS		
	Monitoring	<ul style="list-style-type: none"> - Mobile APP : WiseView - Web viewer : Web client (IE, Safari) - CMS : Wisenet client (win, mac) 		
Remote Monitoring	Web viewer	<p>Supported OS</p> <ul style="list-style-type: none"> - PC : Windows® 7, Windows® 8.1, Windows® 10 - Mac OS X® 10.13.5 or lower <p>Mobile</p> <ul style="list-style-type: none"> - Android Ver 6.0 or higher - iOS 11.4.1 or higher <p>Supported Browser</p> <ul style="list-style-type: none"> - Microsoft Internet Explorer (Ver. 11, 10, 9, 8) - Mozilla Firefox Ver 51.x or lower - Google Chrome Ver 44.x or lower - Safari®11.1.1 or lower 		
	Mobile Transmission speed	APP SPEC has a lot to do with network speed and mobile performance. SPEC is different for different test environments. Data can only be used as a reference.		
	Protocol support	TCP/IP, UDP/IP, UDP		
	Max. remote users	Max 7 (admin+user)		
Storage	Internal HDD	1 SATA HDDs * Support max. 6T		
	File Format (Back-up)	RF, AVI, MP4		
Easy Connection		TUTK P2P (using QR Code)		
Security		User Access Password, Access Log Lists, Encryption (ID/Password)		

Appendix

Item		Details		
		SDR-73306	SDR-74306	SDR-75306
Interface				
Video (* EDID support)	VGA	- 1920x1080 - 1280x1024 - 1280x720 - 1024x768		
	HDMI	- 1920x1080 - 1280x1024 - 1280x720 - 1024x768 - EDID (Auto Detect)		
	Simultaneous Output	VGA and HDMI		
Audio	Inputs/Output	no		
	Compression	no		
	Remote notification	Motion Notification via e-mail		
Connections	Ethernet	1 RJ45 10/100 Base-T		
	USB	2 × USB 2.0 (Front /Rear)		
	Application Support	Mouse		
General				
Color / Material	Ivory/Plastic (Poly Carbonite)	Black / Metal		
Electrical	Input Voltage/Current	DC 12V		
	Power consumption	9W	11W	16W
Environmental	Operating Temperature/ Humidity	- Temperature : 0°C~+40°C (32°F ~ 104°F) - Humidity : 20% ~ 85%RH		
Mechanical	Dimension (W×D×H)	300x227x53mm (11.81"x8.94"x2.09")		
	Weight (Without hard disks)	1.43Kg	1.454Kg	1.748Kg
OSD Language	English, French, Spanish, Portuguse, German, Korean			

DIMENSION

SDR-73306/SDR-74306/SDR-75306

Unit: mm (inch)

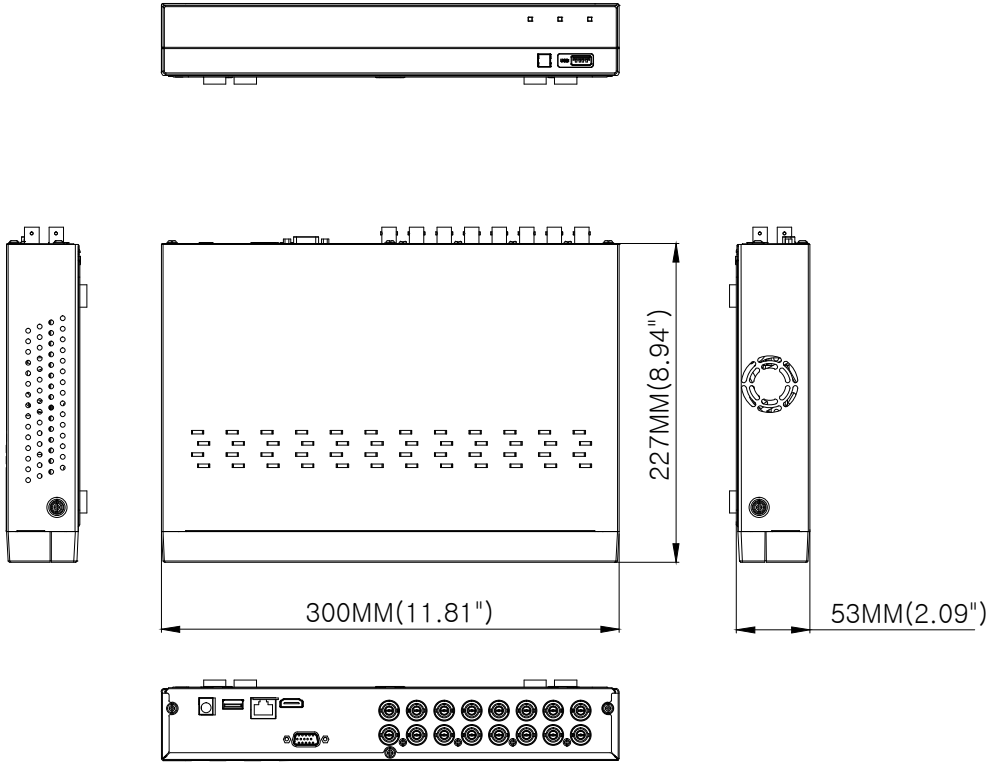

OPEN SOURCE ANNOUNCEMENT

The software included in this product contains copyrighted software that is licensed under the GPL/LGPL. You may obtain the Corresponding Source code from us for a period of three years after our last shipment of this product

If you want to obtain the Corresponding Source code in the physical medium such as CD-ROM, the cost of physically performing source distribution might be charged.

GNU GENERAL PUBLIC LICENSE

Version 2, June 1991

Copyright (C) 1989, 1991 Free Software Foundation, Inc.

51 Franklin Street, Fifth Floor, Boston, MA 02110-1301, USA

Everyone is permitted to copy and distribute verbatim copies of this license document, but changing it is not allowed.

Preamble

The licenses for most software are designed to take away your freedom to share and change it. By contrast, the GNU General Public License is intended to guarantee your freedom to share and change free software to make sure the software is free for all its users. This General Public License applies to most of the Free Software Foundation's software and to any other program whose authors commit to using it. (Some other Free Software Foundation software is covered by the GNU Lesser General Public License instead.) You can apply it to your programs, too.

When we speak of free software, we are referring to freedom, not price. Our General Public Licenses are designed to make sure that you have the freedom to distribute copies of free software (and charge for this service if you wish), that you receive source code or can get it if you want it, that you can change the software or use pieces of it in new free programs; and that you know you can do these things.

To protect your rights, we need to make restrictions that forbid anyone to deny you these rights or to ask you to surrender the rights. These restrictions translate to certain responsibilities for you if you distribute copies of the software, or if you modify it.

For example, if you distribute copies of such a program, whether gratis or for a fee, you must give the recipients all the rights that you have. You must make sure that they, too, receive or can get the source code. And you must show them these terms so they know their rights.

We protect your rights with two steps:

(1) copyright the software, and (2) offer you this license which gives you legal permission to copy, distribute and/or modify the software.

Also, for each author's protection and ours, we want to make certain that everyone understands that there is no warranty for this free software. If the software is modified by someone else and passed on, we want its recipients to know that what they have is not the original, so that any problems introduced by others will not reflect on the original authors' reputations.

Finally, any free program is threatened constantly by software patents. We wish to avoid the danger that redistributors of a free program will individually obtain patent licenses, in effect making the program proprietary. To prevent this, we have made it clear that any patent must be licensed for everyone's free use or not licensed at all. The precise terms and conditions for copying, distribution and modification follow.

TERMS AND CONDITIONS FOR COPYING, DISTRIBUTION AND MODIFICATION

Version 2, June 1991

Copyright (C) 1989, 1991 Free Software Foundation, Inc.

51 Franklin S

0. This License applies to any program or other work which contains a notice placed by the copyright holder saying it may be distributed under the terms of this General Public License. The "Program", below, refers to any such program or work, and a "work based on the Program" means either the Program or any derivative work under copyright law: that is to say, a work containing the Program or a portion of it, either verbatim or with modifications and/or translated into another language. (Hereinafter, translation is included without limitation in the term "modification".) Each licensee is addressed as "you".

Activities other than copying, distribution and modification are not covered by this License; they are outside its scope. The act of running the Program is not restricted, and the output from the Program is covered only if its contents constitute a work based on the Program (independent of having been made by running the Program). Whether that is true depends on what the Program does.

1. You may copy and distribute verbatim copies of the Program's source code as you receive it, in any medium, provided that you conspicuously and appropriately publish on each copy an appropriate copyright notice and disclaimer of warranty; keep intact all the notices that refer to this License and to the absence of any warranty; and give any other recipients of the Program a copy of this License along with the Program.

You may charge a fee for the physical act of transferring a copy, and you may at your option offer warranty protection in exchange for a fee.

2. You may modify your copy or copies of the Program or any portion of it, thus forming a work based on the Program, and copy and distribute such modifications or work under the terms of Section 1 above, provided that you also meet all of these conditions:

- You must cause the modified files to carry prominent notices stating that you changed the files and the date of any change.
- You must cause any work that you distribute or publish, that in whole or in part contains or is derived from the Program or any part thereof, to be licensed as a whole at no charge to all third parties under the terms of this License.
- If the modified program normally reads commands interactively when run, you must cause it, when started running for such interactive use in the most ordinary way, to print or display an announcement including an appropriate copyright notice and a notice that there is no warranty (or else, saying that you provide a warranty) and that users may redistribute the program under these conditions, and telling the user how to view a copy of this License. (Exception: if the Program itself is interactive but does not normally print such an announcement, your work based on the Program is not required to print an announcement.)

These requirements apply to the modified work as a whole. If identifiable sections of that work are not derived from the Program, and can be reasonably considered independent and separate works in themselves, then this License, and its terms, do not apply to those sections when you distribute them as separate works. But when you distribute the same sections as part of a whole which is a work based on the Program, the distribution of the whole must be on the terms of this License, whose permissions for other licensees extend to the entire whole, and thus to each and every part regardless of who wrote it.

Thus, it is not the intent of this section to claim rights or contest your rights to work written entirely by you; rather, the intent is to exercise the right to control the distribution of derivative or collective works based on the Program.

In addition, mere aggregation of another work not based on the Program with the Program (or with a work based on the Program) on a volume of a storage or distribution medium does not bring the other work under the scope of this License.

3. You may copy and distribute the Program (or a work based on it, under Section 2) in object code or executable form under the terms of Sections 1 and 2 above provided that you also do one of the following:

- Accompany it with the complete corresponding machine-readable source code, which must be distributed under the terms of Sections 1 and 2 above on a medium customarily used for software interchange; or,
- Accompany it with a written offer, valid for at least three years, to give any third party, for a charge no more than your cost of physically performing source distribution, a complete machine-readable copy of the corresponding source code, to be distributed under the terms of Sections 1 and 2 above on a medium customarily used for software interchange; or,

- c) Accompany it with the information you received as to the offer to distribute corresponding source code. (This alternative is allowed only for noncommercial distribution and only if you received the program in object code or executable form with such an offer, in accord with Subsection b above.)

The source code for a work means the preferred form of the work for making modifications to it. For an executable work, complete source code means all the source code for all modules it contains, plus any associated interface definition files, plus the scripts used to control compilation and installation of the executable. However, as a special exception, the source code distributed need not include anything that is normally distributed (in either source or binary form) with the major components (compiler, kernel, and so on) of the operating system on which the executable runs, unless that component itself accompanies the executable.

If distribution of executable or object code is made by offering access to copy from a designated place, then offering equivalent access to copy the source code from the same place counts as distribution of the source code, even though third parties are not compelled to copy the source along with the object code.

4. You may not copy, modify, sublicense, or distribute the Program except as expressly provided under this License. Any attempt otherwise to copy, modify, sublicense or distribute the Program is void, and will automatically terminate your rights under this License. However, parties who have received copies, or rights, from you under this License will not have their licenses terminated so long as such parties remain in full compliance.

5. You are not required to accept this License, since you have not signed it. However, nothing else grants you permission to modify or distribute the Program or its derivative works. These actions are prohibited by law if you do not accept this License. Therefore, by modifying or distributing the Program (or any work based on the Program), you indicate your acceptance of this License to do so, and all its terms and conditions for copying, distributing or modifying the Program or works based on it.

6. Each time you redistribute the Program (or any work based on the Program), the recipient automatically receives a license from the original licensor to copy, distribute or modify the Program subject to these terms and conditions. You may not impose any further restrictions on the recipients' exercise of the rights granted herein. You are not responsible for enforcing compliance by third parties to this License.

7. If, as a consequence of a court judgment or allegation of patent infringement or for any other reason (not limited to patent issues), conditions are imposed on you (whether by court order, agreement or otherwise) that contradict the conditions of this License, they do not excuse you from the conditions of this License. If you cannot distribute so as to satisfy simultaneously your obligations under this License and any other pertinent obligations, then as a consequence you may not distribute the Program at all. For example, if a patent license would not permit royalty-free redistribution of the Program by all those who receive copies directly or indirectly through you, then the only way you could satisfy both it and this License would be to refrain entirely from distribution of the Program.

If any portion of this section is held invalid or unenforceable under any particular circumstance, the balance of the section is intended to apply and the section as a whole is intended to apply in other circumstances.

It is not the purpose of this section to induce you to infringe any patents or other property right claims or to contest validity of any such claims; this section has the sole purpose of protecting the integrity of the free software distribution system, which is implemented by public license practices. Many people have made generous contributions to the wide range of software distributed through that system in reliance on consistent application of that system; it is up to the author/donor to decide if he or she is willing to distribute software through any other system and a licensee cannot impose that choice.

This section is intended to make thoroughly clear what is believed to be a consequence of the rest of this License.

8. If the distribution and/or use of the Program is restricted in certain countries either by patents or by copyrighted interfaces, the original copyright holder who places the Program under this License may add an explicit geographical distribution limitation excluding those countries, so that distribution is permitted only in or among countries not thus excluded. In such case, this License incorporates the limitation as if written in the body of this License.

9. The Free Software Foundation may publish revised and/or new versions of the General Public License from time to time. Such new versions will be similar in spirit to the present version, but may differ in detail to address new problems or concerns.

Each version is given a distinguishing version number. If the Program specifies a version number of this License which applies to it and "any later version", you have the option of following the terms and conditions either of that version or of any later version published by the Free Software Foundation. If the Program does not specify a version number

of this License, you may choose any version ever published by the Free Software Foundation.

10. If you wish to incorporate parts of the Program into other free programs whose distribution conditions are different, write to the author to ask for permission. For software which is copyrighted by the Free Software Foundation, write to the Free Software Foundation; we sometimes make exceptions for this. Our decision will be guided by the two goals of preserving the free status of all derivatives of our free software and of promoting the sharing and reuse of software generally.

NO WARRANTY

11. BECAUSE THE PROGRAM IS LICENSED FREE OF CHARGE, THERE IS NO WARRANTY FOR THE PROGRAM, TO THE EXTENT PERMITTED BY APPLICABLE LAW. EXCEPT WHEN OTHERWISE STATED IN WRITING THE COPYRIGHT HOLDERS AND/OR OTHER PARTIES PROVIDE THE PROGRAM "AS IS" WITHOUT WARRANTY OF ANY KIND, EITHER EXPRESSED OR IMPLIED, INCLUDING, BUT NOT LIMITED TO, THE IMPLIED WARRANTIES OF MERCHANTABILITY AND FITNESS FOR A PARTICULAR PURPOSE. THE ENTIRE RISK AS TO THE QUALITY AND PERFORMANCE OF THE PROGRAM IS WITH YOU. SHOULD THE PROGRAM PROVE DEFECTIVE, YOU ASSUME THE COST OF ALL NECESSARY SERVICING, REPAIR OR CORRECTION.

12. IN NO EVENT UNLESS REQUIRED BY APPLICABLE LAW OR AGREED TO IN WRITING WILL ANY COPYRIGHT HOLDER, OR ANY OTHER PARTY WHO MAY MODIFY AND/OR REDISTRIBUTE THE PROGRAM AS PERMITTED ABOVE, BE LIABLE TO YOU FOR DAMAGES, INCLUDING ANY GENERAL, SPECIAL, INCIDENTAL OR CONSEQUENTIAL DAMAGES ARISING OUT OF THE USE OR INABILITY TO USE THE PROGRAM (INCLUDING BUT NOT LIMITED TO LOSS OF DATA OR DATA BEING RENDERED INACCURATE OR LOSSES SUSTAINED BY YOU OR THIRD PARTIES OR A FAILURE OF THE PROGRAM TO OPERATE WITH ANY OTHER PROGRAMS), EVEN IF SUCH HOLDER OR OTHER PARTY HAS BEEN ADVISED OF THE POSSIBILITY OF SUCH DAMAGES.

END OF TERMS AND CONDITIONS

How to Apply These Terms to Your New Programs

If you develop a new program, and you want it to be of the greatest possible use to the public, the best way to achieve this is to make it free software which everyone can redistribute and change under these terms.

To do so, attach the following notices to the program. It is safest to attach them to the start of each source file to most effectively convey the exclusion of warranty; and each file should have at least the "copyright" line and a pointer to where the full notice is found.

one line to give the program's name and an idea of what it does.

Copyright (C) yyyy name of author

This program is free software; you can redistribute it and/or modify it under the terms of the GNU General Public License as published by the Free Software Foundation; either version 2 of the License, or (at your option) any later version.

This program is distributed in the hope that it will be useful, but WITHOUT ANY WARRANTY; without even the implied warranty of MERCHANTABILITY or FITNESS FOR A PARTICULAR PURPOSE. See the GNU General Public License for more details.

You should have received a copy of the GNU General Public License along with this program; if not, write to the Free Software Foundation, Inc., 51 Franklin Street, Fifth Floor, Boston, MA 02110-1301, USA.

Also add information on how to contact you by electronic and paper mail. If the program is interactive, make it output a short notice like this when it starts in an interactive mode:

Gnomovision version 69, Copyright (C) year name of author
Gnomovision comes with ABSOLUTELY NO WARRANTY; for details type 'show w'. This is free software, and you are welcome to redistribute it under certain conditions; type 'show c' for details.

The hypothetical commands 'show w' and 'show c' should show the appropriate parts of the General Public License. Of course, the commands you use may be called something other than 'show w' and 'show c'; they could even be mouse-clicks or menu items--whatever suits your program.

You should also get your employer (if you work as a programmer) or your school, if any, to sign a "copyright disclaimer" for the program, if necessary. Here is a sample; alter the names:

Yoyodyne, Inc., hereby disclaims all copyright interest in the program 'Gnomovision' (which makes passes at compilers) written by James Hacker.

signature of Ty Coon, 1 April 1989 Ty Coon, President of Vice This General Public License does not permit incorporating your program into proprietary programs. If your program is a subroutine library, you may

consider it more useful to permit linking proprietary applications with the library. If this is what you want to do, use the GNU Lesser General Public License instead of this License.

GNU GENERAL PUBLIC LICENSE

Version 3, 29 June 2007

Copyright © 2007 Free Software Foundation, Inc. <<http://fsf.org/>>

Everyone is permitted to copy and distribute verbatim copies of this license document, but changing it is not allowed.

Preamble

The GNU General Public License is a free, copyleft license for software and other kinds of works.

The licenses for most software and other practical works are designed to take away your freedom to share and change the works. By contrast, the GNU General Public License is intended to guarantee your freedom to share and change all versions of a program—to make sure it remains free software for all its users. We, the Free Software Foundation, use the GNU General Public License for most of our software; it applies also to any other work released this way by its authors. You can apply it to your programs, too.

When we speak of free software, we are referring to freedom, not price. Our General Public Licenses are designed to make sure that you have the freedom to distribute copies of free software (and charge for them if you wish), that you receive source code or can get it if you want it, that you can change the software or use pieces of it in new free programs, and that you know you can do these things.

To protect your rights, we need to prevent others from denying you these rights or asking you to surrender the rights. Therefore, you have certain responsibilities if you distribute copies of the software, or if you modify it: responsibilities to respect the freedom of others.

For example, if you distribute copies of such a program, whether gratis or for a fee, you must pass on to the recipients the same freedoms that you received. You must make sure that they, too, receive or can get the source code. And you must show them these terms so they know their rights.

Developers that use the GNU GPL protect your rights with two steps: (1) assert copyright on the software, and (2) offer you this License giving you legal permission to copy, distribute and/or modify it.

For the developers' and authors' protection, the GPL clearly explains that there is no warranty for this free software. For both users' and authors' sake, the GPL requires that modified versions be marked as changed, so that their problems will not be attributed erroneously to authors of previous versions.

Some devices are designed to deny users access to install or run modified versions of the software inside them, although the manufacturer can do so. This is fundamentally incompatible with the aim of protecting users' freedom to change the software. The systematic pattern of such abuse occurs in the area of products for individuals to use, which is precisely where it is most unacceptable. Therefore, we have designed this version of the GPL to prohibit the practice for those products. If such problems arise substantially in other domains, we stand ready to extend this provision to those domains in future versions of the GPL, as needed to protect the freedom of users.

Finally, every program is threatened constantly by software patents. States should not allow patents to restrict development and use of software on general-purpose computers, but in those that do, we wish to avoid the special danger that patents applied to a free program could make it effectively proprietary. To prevent this, the GPL assures that patents cannot be used to render the program non-free.

The precise terms and conditions for copying, distribution and modification follow.

TERMS AND CONDITIONS

0. Definitions.

"This License" refers to version 3 of the GNU General Public License.

"Copyright" also means copyright-like laws that apply to other kinds of works, such as semiconductor masks.

"The Program" refers to any copyrightable work licensed under this License. Each licensee is addressed as "you". "Licensees" and "recipients" may be individuals or organizations.

To "modify" a work means to copy from or adapt all or part of the work in a fashion requiring copyright permission, other than the making of an exact copy. The resulting work is called a "modified version" of the earlier work or a work "based on" the earlier work.

A "covered work" means either the unmodified Program or a work based on the Program.

To "propagate" a work means to do anything with it that, without permission, would make you directly or secondarily liable for infringement under applicable copyright law, except executing it on a

computer or modifying a private copy. Propagation includes copying, distribution (with or without modification), making available to the public, and in some countries other activities as well.

To "convey" a work means any kind of propagation that enables other parties to make or receive copies. Mere interaction with a user through a computer network, with no transfer of a copy, is not conveying.

An interactive user interface displays "Appropriate Legal Notices" to the extent that it includes a convenient and prominently visible feature that (1) displays an appropriate copyright notice, and (2) tells the user that there is no warranty for the work (except to the extent that warranties are provided), that licensees may convey the work under this License, and how to view a copy of this License. If the interface presents a list of user commands or options, such as a menu, a prominent item in the list meets this criterion.

1. Source Code.

The "source code" for a work means the preferred form of the work for making modifications to it. "Object code" means any non-source form of a work.

A "Standard Interface" means an interface that either is an official standard defined by a recognized standards body, or, in the case of interfaces specified for a particular programming language, one that is widely used among developers working in that language.

The "System Libraries" of an executable work include anything, other than the work as a whole, that (a) is included in the normal form of packaging a Major Component, but which is not part of that Major Component, and (b) serves only to enable use of the work with that Major Component, or to implement a Standard Interface for which an implementation is available to the public in source code form. A "Major Component", in this context, means a major essential component (kernel, window system, and so on) of the specific operating system (if any) on which the executable work runs, or a compiler used to produce the work, or an object code interpreter used to run it.

The "Corresponding Source" for a work in object code form means all the source code needed to generate, install, and (for an executable work) run the object code and to modify the work, including scripts to control those activities. However, it does not include the work's System Libraries, or general-purpose tools or generally available free programs which are used unmodified in performing those activities but which are not part of the work. For example, Corresponding Source includes interface definition files associated with source files for the work, and the source code for shared libraries and dynamically linked subprograms that the work is specifically designed to require, such as by intimate data communication or control flow between those subprograms and other parts of the work.

The Corresponding Source need not include anything that users can regenerate automatically from other parts of the Corresponding Source.

The Corresponding Source for a work in source code form is that same work.

2. Basic Permissions.

All rights granted under this License are granted for the term of copyright on the Program, and are irrevocable provided the stated conditions are met. This License explicitly affirms your unlimited permission to run the unmodified Program. The output from running a covered work is covered by this License only if the output, given its content, constitutes a covered work. This License acknowledges your rights of fair use or other equivalent, as provided by copyright law.

You may make, run and propagate covered works that you do not convey, without conditions so long as your license otherwise remains in force. You may convey covered works to others for the sole purpose of having them make modifications exclusively for you, or provide you with facilities for running those works, provided that you comply with the terms of this License in conveying all material for which you do not control copyright. Those thus making or running the covered works for you must do so exclusively on your behalf, under your direction and control, on terms that prohibit them from making any copies of your copyrighted material outside their relationship with you.

Conveying under any other circumstances is permitted solely under the conditions stated below. Sublicensing is not allowed; section 10 makes it unnecessary.

3. Protecting Users' Legal Rights From Anti-Circumvention Law.

No covered work shall be deemed part of an effective technological measure under any applicable law fulfilling obligations under article 11 of the WIPO copyright treaty adopted on 20 December 1996, or similar laws prohibiting or restricting circumvention of such measures.

When you convey a covered work, you waive any legal power to forbid circumvention of technological measures to the extent such circumvention is effected by exercising rights under this License with respect to the covered work, and you disclaim any intention to limit operation or modification of the work as a means of enforcing, against the work's users, your or third parties' legal rights to forbid circumvention of technological measures.

4. Conveying Verbatim Copies.

You may convey verbatim copies of the Program's source code as you receive it, in any medium, provided that you conspicuously and appropriately publish on each copy an appropriate copyright notice; keep intact all notices stating that this License and any non-permissive terms added in accord with section 7 apply to the code; keep intact all notices of the absence of any warranty; and give all recipients a copy of this License along with the Program.

You may charge any price or no price for each copy that you convey, and you may offer support or warranty protection for a fee.

5. Conveying Modified Source Versions.

You may convey a work based on the Program, or the modifications to produce it from the Program, in the form of source code under the terms of section 4, provided that you also meet all of these conditions:

- a) The work must carry prominent notices stating that you modified it, and giving a relevant date.
- b) The work must carry prominent notices stating that it is released under this License and any conditions added under section 7. This requirement modifies the requirement in section 4 to "keep intact all notices".
- c) You must license the entire work, as a whole, under this License to anyone who comes into possession of a copy. This License will therefore apply, along with any applicable section 7 additional terms, to the whole of the work, and all its parts, regardless of how they are packaged. This License gives no permission to license the work in any other way, but it does not invalidate such permission if you have separately received it.
- d) If the work has interactive user interfaces, each must display Appropriate Legal Notices; however, if the Program has interactive interfaces that do not display Appropriate Legal Notices, your work need not make them do so.

A compilation of a covered work with other separate and independent works, which are not by their nature extensions of the covered work, and which are not combined with it such as to form a larger program, in or on a volume of a storage or distribution medium, is called an "aggregate" if the compilation and its resulting copyright are not used to limit the access or legal rights of the compilation's users beyond what the individual works permit. Inclusion of a covered work in an aggregate does not cause this License to apply to the other parts of the aggregate.

6. Conveying Non-Source Forms.

You may convey a covered work in object code form under the terms of sections 4 and 5, provided that you also convey the machine-readable Corresponding Source under the terms of this License, in one of these ways:

- a) Convey the object code in, or embodied in, a physical product (including a physical distribution medium), accompanied by the Corresponding Source fixed on a durable physical medium customarily used for software interchange.
- b) Convey the object code in, or embodied in, a physical product (including a physical distribution medium), accompanied by a written offer, valid for at least three years and valid for as long as you offer spare parts or customer support for that product model, to give anyone who possesses the object code either (1) a copy of the Corresponding Source for all the software in the product that is covered by this License, on a durable physical medium customarily used for software interchange, for a price no more than your reasonable cost of physically performing this conveying of source, or (2) access to copy the Corresponding Source from a network server at no charge.
- c) Convey individual copies of the object code with a copy of the written offer to provide the Corresponding Source. This alternative is allowed only occasionally and noncommercially, and only if you received the object code with such an offer, in accord with subsection 6b.
- d) Convey the object code by offering access from a designated place (gratis or for a charge), and offer equivalent access to the Corresponding Source in the same way through the same place at no further charge. You need not require recipients to copy the Corresponding Source along with the object code. If the place to copy the object code is a network server, the Corresponding Source may be on a different server (operated by you or a third party) that supports equivalent copying facilities, provided you maintain clear directions next to the object code saying where to find the Corresponding Source. Regardless of what server hosts the Corresponding Source, you remain obligated to ensure that it is available for as long as needed to satisfy these requirements.
- e) Convey the object code using peer-to-peer transmission, provided you inform other peers where the object code and Corresponding Source of the work are being offered to the general public at no charge under subsection 6d.

A separable portion of the object code, whose source code is excluded from the Corresponding Source as a System Library, need not be included in conveying the object code work.

A "User Product" is either (1) a "consumer product", which means any tangible personal property which is normally used for personal, family, or household purposes, or (2) anything designed or sold for incorporation into a dwelling. In determining whether a product is a consumer product, doubtful cases shall be resolved in favor of coverage. For a particular product received by a particular user, "normally used" refers to a typical or common use of that class of product, regardless of the status of the particular user or of the way in which the particular user actually uses, or expects or is expected to use, the product. A product is a consumer product regardless of whether the product has substantial commercial, industrial or non-consumer uses, unless such uses represent the only significant mode of use of the product.

"Installation Information" for a User Product means any methods, procedures, authorization keys, or other information required to install and execute modified versions of a covered work in that User Product from a modified version of its Corresponding Source. The information must suffice to ensure that the continued functioning of the modified object code is in no case prevented or interfered with solely because modification has been made.

If you convey an object code work under this section in, or with, or specifically for use in, a User Product, and the conveying occurs as part of a transaction in which the right of possession and use of the User Product is transferred to the recipient in perpetuity or for a fixed term (regardless of how the transaction is characterized), the Corresponding Source conveyed under this section must be accompanied by the Installation Information. But this requirement does not apply if neither you nor any third party retains the ability to install modified object code on the User Product (for example, the work has been installed in ROM).

The requirement to provide Installation Information does not include a requirement to continue to provide support service, warranty, or updates for a work that has been modified or installed by the recipient, or for the User Product in which it has been modified or installed. Access to a network may be denied when the modification itself materially and adversely affects the operation of the network or violates the rules and protocols for communication across the network.

Corresponding Source conveyed, and Installation Information provided, in accord with this section must be in a format that is publicly documented (and with an implementation available to the public in source code form), and must require no special password or key for unpacking, reading or copying.

7. Additional Terms.

"Additional permissions" are terms that supplement the terms of this License by making exceptions from one or more of its conditions. Additional permissions that are applicable to the entire Program shall be treated as though they were included in this License, to the extent that they are valid under applicable law. If additional permissions apply only to part of the Program, that part may be used separately under those permissions, but the entire Program remains governed by this License without regard to the additional permissions.

When you convey a copy of a covered work, you may at your option remove any additional permissions from that copy, or from any part of it. (Additional permissions may be written to require their own removal in certain cases when you modify the work.) You may place additional permissions on material, added by you to a covered work, for which you have or can give appropriate copyright permission.

Notwithstanding any other provision of this License, for material you add to a covered work, you may (if authorized by the copyright holders of that material) supplement the terms of this License with terms:

- a) Disclaiming warranty or limiting liability differently from the terms of sections 15 and 16 of this License; or
- b) Requiring preservation of specified reasonable legal notices or author attributions in that material or in the Appropriate Legal Notices displayed by works containing it; or
- c) Prohibiting misrepresentation of the origin of that material, or requiring that modified versions of such material be marked in reasonable ways as different from the original version; or
- d) Limiting the use for publicity purposes of names of licensors or authors of the material; or
- e) Declining to grant rights under trademark law for use of some trade names, trademarks, or service marks; or
- f) Requiring indemnification of licensors and authors of that material by anyone who conveys the material (or modified versions of it) with contractual assumptions of liability to the recipient, for any liability that these contractual assumptions directly impose on those licensors and authors.

All other non-permissive additional terms are considered "further restrictions" within the meaning of section 10. If the Program as you received it, or any part of it, contains a notice stating that it is governed by this License along with a term that is a further restriction, you may remove that term. If a license document contains a further restriction but

permits relicensing or conveying under this License, you may add to a covered work material governed by the terms of that license document, provided that the further restriction does not survive such relicensing or conveying.

If you add terms to a covered work in accord with this section, you must place, in the relevant source files, a statement of the additional terms that apply to those files, or a notice indicating where to find the applicable terms.

Additional terms, permissive or non-permissive, may be stated in the form of a separately written license, or stated as exceptions; the above requirements apply either way.

8. Termination.

You may not propagate or modify a covered work except as expressly provided under this License. Any attempt otherwise to propagate or modify it is void, and will automatically terminate your rights under this License (including any patent licenses granted under the third paragraph of section 11).

However, if you cease all violation of this License, then your license from a particular copyright holder is reinstated (a) provisionally, unless and until the copyright holder explicitly and finally terminates your license, and (b) permanently, if the copyright holder fails to notify you of the violation by some reasonable means prior to 60 days after the cessation.

Moreover, your license from a particular copyright holder is reinstated permanently if the copyright holder notifies you of the violation by some reasonable means, this is the first time you have received notice of violation of this License (for any work) from that copyright holder, and you cure the violation prior to 30 days after your receipt of the notice.

Termination of your rights under this section does not terminate the licenses of parties who have received copies or rights from you under this License. If your rights have been terminated and not permanently reinstated, you do not qualify to receive new licenses for the same material under section 10.

9. Acceptance Not Required for Having Copies.

You are not required to accept this License in order to receive or run a copy of the Program. Ancillary propagation of a covered work occurring solely as a consequence of using peer-to-peer transmission to receive a copy likewise does not require acceptance. However, nothing other than this License grants you permission to propagate or modify any covered work. These actions infringe copyright if you do not accept this License. Therefore, by modifying or propagating a covered work, you indicate your acceptance of this License to do so.

10. Automatic Licensing of Downstream Recipients.

Each time you convey a covered work, the recipient automatically receives a license from the original licensors, to run, modify and propagate that work, subject to this License. You are not responsible for enforcing compliance by third parties with this License.

An "entity transaction" is a transaction transferring control of an organization, or substantially all assets of one, or subdividing an organization, or merging organizations. If propagation of a covered work results from an entity transaction, each party to that transaction who receives a copy of the work also receives whatever licenses to the work the party's predecessor in interest had or could give under the previous paragraph, plus a right to possession of the Corresponding Source of the work from the predecessor in interest, if the predecessor has it or can get it with reasonable efforts.

You may not impose any further restrictions on the exercise of the rights granted or affirmed under this License. For example, you may not impose a license fee, royalty, or other charge for exercise of rights granted under this License, and you may not initiate litigation (including a cross-claim or counterclaim in a lawsuit) alleging that any patent claim is infringed by making, using, selling, offering for sale, or importing the Program or any portion of it.

11. Patents.

A "contributor" is a copyright holder who authorizes use under this License of the Program or a work on which the Program is based. The work thus licensed is called the contributor's "contributor version".

A contributor's "essential patent claims" are all patent claims owned or controlled by the contributor, whether already acquired or hereafter acquired, that would be infringed by some manner, permitted by this License, of making, using, or selling its contributor version, but do not include claims that would be infringed only as a consequence of further modification of the contributor version. For purposes of this definition, "control" includes the right to grant patent sublicenses in a manner consistent with the requirements of this License.

Each contributor grants you a non-exclusive, worldwide, royalty-free patent license under the contributor's essential patent claims, to make, use, sell, offer for sale, import and otherwise run, modify and propagate the contents of its contributor version.

In the following three paragraphs, a "patent license" is any express agreement or commitment, however denominated, not to enforce a patent (such as an express permission to practice a patent or covenant not to sue for patent infringement). To "grant" such a patent license to a party means to make such an agreement or commitment not to enforce a patent against the party.

If you convey a covered work, knowingly relying on a patent license, and the Corresponding Source of the work is not available for anyone to copy, free of charge and under the terms of this License, through a publicly available network server or other readily accessible means, then you must either (1) cause the Corresponding Source to be so available, or (2) arrange to deprive yourself of the benefit of the patent license for this particular work, or (3) arrange, in a manner consistent with the requirements of this License, to extend the patent license to downstream recipients. "Knowingly relying" means you have actual knowledge that, but for the patent license, your conveying the covered work in a country, or your recipient's use of the covered work in a country, would infringe one or more identifiable patents in that country that you have reason to believe are valid.

If, pursuant to or in connection with a single transaction or arrangement, you convey, or propagate by procuring conveyance of, a covered work, and grant a patent license to some of the parties receiving the covered work authorizing them to use, propagate, modify or convey a specific copy of the covered work, then the patent license you grant is automatically extended to all recipients of the covered work and works based on it.

A patent license is "discriminatory" if it does not include within the scope of its coverage, prohibits the exercise of, or is conditioned on the non-exercise of one or more of the rights that are specifically granted under this License. You may not convey a covered work if you are a party to an arrangement with a third party that is in the business of distributing software, under which you make payment to the third party based on the extent of your activity of conveying the work, and under which the third party grants, to any of the parties who would receive the covered work from you, a discriminatory patent license (a) in connection with copies of the covered work conveyed by you (or copies made from those copies), or (b) primarily for and in connection with specific products or compilations that contain the covered work, unless you entered into that arrangement, or that patent license was granted, prior to 28 March 2007.

Nothing in this License shall be construed as excluding or limiting any implied license or other defenses to infringement that may otherwise be available to you under applicable patent law.

12. No Surrender of Others' Freedom.

If conditions are imposed on you (whether by court order, agreement or otherwise) that contradict the conditions of this License, they do not excuse you from the conditions of this License. If you cannot convey a covered work so as to satisfy simultaneously your obligations under this License and any other pertinent obligations, then as a consequence you may not convey it at all. For example, if you agree to terms that obligate you to collect a royalty for further conveying from those to whom you convey the Program, the only way you could satisfy both those terms and this License would be to refrain entirely from conveying the Program.

13. Use with the GNU Affero General Public License.

Notwithstanding any other provision of this License, you have permission to link or combine any covered work with a work licensed under version 3 of the GNU Affero General Public License into a single combined work, and to convey the resulting work. The terms of this License will continue to apply to the part which is the covered work, but the special requirements of the GNU Affero General Public License, section 13, concerning interaction through a network will apply to the combination as such.

14. Revised Versions of this License.

The Free Software Foundation may publish revised and/or new versions of the GNU General Public License from time to time. Such new versions will be similar in spirit to the present version, but may differ in detail to address new problems or concerns.

Each version is given a distinguishing version number. If the Program specifies that a certain numbered version of the GNU General Public License "or any later version" applies to it, you have the option of following the terms and conditions either of that numbered version or of any later version published by the Free Software Foundation. If the Program does not specify a version number of the GNU General Public License, you may choose any version ever published by the Free Software Foundation.

If the Program specifies that a proxy can decide which future versions of the GNU General Public License can be used, that proxy's public statement of acceptance of a version permanently authorizes you to choose that version for the Program.

Later license versions may give you additional or different permissions. However, no additional obligations are imposed on any author or copyright holder as a result of your choosing to follow a later version.

15. Disclaimer of Warranty.

THERE IS NO WARRANTY FOR THE PROGRAM, TO THE EXTENT PERMITTED BY APPLICABLE LAW. EXCEPT WHEN OTHERWISE STATED IN WRITING THE COPYRIGHT HOLDERS AND/OR OTHER PARTIES PROVIDE THE PROGRAM "AS IS" WITHOUT WARRANTY OF ANY KIND, EITHER EXPRESSED OR IMPLIED, INCLUDING, BUT NOT LIMITED TO, THE IMPLIED WARRANTIES OF MERCHANTABILITY AND FITNESS FOR A PARTICULAR PURPOSE. THE ENTIRE RISK AS TO THE QUALITY AND PERFORMANCE OF THE PROGRAM IS WITH YOU. SHOULD THE PROGRAM PROVE DEFECTIVE, YOU ASSUME THE COST OF ALL NECESSARY SERVICING, REPAIR OR CORRECTION.

16. Limitation of Liability.

IN NO EVENT UNLESS REQUIRED BY APPLICABLE LAW OR AGREED TO IN WRITING WILL ANY COPYRIGHT HOLDER, OR ANY OTHER PARTY WHO MODIFIES AND/OR CONVEYS THE PROGRAM AS PERMITTED ABOVE, BE LIABLE TO YOU FOR DAMAGES, INCLUDING ANY GENERAL, SPECIAL, INCIDENTAL OR CONSEQUENTIAL DAMAGES ARISING OUT OF THE USE OR INABILITY TO USE THE PROGRAM (INCLUDING BUT NOT LIMITED TO LOSS OF DATA OR DATA BEING RENDERED INACCURATE OR LOSSES SUSTAINED BY YOU OR THIRD PARTIES OR A FAILURE OF THE PROGRAM TO OPERATE WITH ANY OTHER PROGRAMS), EVEN IF SUCH HOLDER OR OTHER PARTY HAS BEEN ADVISED OF THE POSSIBILITY OF SUCH DAMAGES.

17. Interpretation of Sections 15 and 16.

If the disclaimer of warranty and limitation of liability provided above cannot be given local legal effect according to their terms, reviewing courts shall apply local law that most closely approximates an absolute waiver of all civil liability in connection with the Program, unless a warranty or assumption of liability accompanies a copy of the Program in return for a fee.

END OF TERMS AND CONDITIONS

GNU LESSER GENERAL PUBLIC LICENSE

Version 2.1, February 1999

Copyright (C) 1991, 1999 Free Software Foundation, Inc.

51 Franklin Street, Fifth Floor, Boston, MA 02110-1301 USA

Everyone is permitted to copy and distribute verbatim copies of this license document, but changing it is not allowed.

[This is the first released version of the Lesser GPL. It also counts as the successor of the GNU Library Public License, version 2, hence the version number 2.1.]

Preamble

The licenses for most software are designed to take away your freedom to share and change it. By contrast, the GNU General Public Licenses are intended to guarantee your freedom to share and change free software to make sure the software is free for all its users.

This license, the Lesser General Public License, applies to some specially designated software packages--typically libraries--of the Free Software Foundation and other authors who decide to use it. You can use it too, but we suggest you first think carefully about whether this license or the ordinary General Public License is the better strategy to use in any particular case, based on the explanations below.

When we speak of free software, we are referring to freedom of use, not price. Our General Public Licenses are designed to make sure that you have the freedom to distribute copies of free software (and charge for this service if you wish); that you receive source code or can get it if you want it; that you can change the software and use pieces of it in new free programs; and that you are informed that you can do these things.

To protect your rights, we need to make restrictions that forbid distributors to deny you these rights or to ask you to surrender these rights. These restrictions translate to certain responsibilities for you if you distribute copies of the library or if you modify it.

For example, if you distribute copies of the library, whether gratis or for a fee, you must give the recipients all the rights that we gave you. You must make sure that they, too, receive or can get the source code. If you link other code with the library, you must provide complete object files to the recipients, so that they can relink them with the library after making changes to the library and recompiling it. And you must show them these terms so they know their rights.

We protect your rights with a two-step method: (1) we copyright the library, and (2) we offer you this license, which gives you legal permission to copy, distribute and/or modify the library.

To protect each distributor, we want to make it very clear that there is no warranty for the free library. Also, if the library is modified by someone else and passed on, the recipients should know that what they have is not the original version, so that the original author's reputation will not be affected by problems that might be introduced by others.

Finally, software patents pose a constant threat to the existence of any free program. We wish to make sure that a company cannot effectively restrict the users of a free program by obtaining a restrictive license from a patent holder. Therefore, we insist that any patent license obtained for a version of the library must be consistent with the full freedom of use specified in this license.

Most GNU software, including some libraries, is covered by the ordinary GNU General Public License. This license, the GNU Lesser General Public License, applies to certain designated libraries, and is quite different from the ordinary General Public License. We use this license for certain libraries in order to permit linking those libraries into non-free programs.

When a program is linked with a library, whether statically or using a shared library, the combination of the two is legally speaking a combined work, a derivative of the original library. The ordinary General Public License therefore permits such linking only if the entire combination fits its criteria of freedom. The Lesser General Public License permits more lax criteria for linking other code with the library.

We call this license the "Lesser" General Public License because it does Less to protect the user's freedom than the ordinary General Public License. It also provides other free software developers Less of an advantage over competing non-free programs. These disadvantages are the reason we use the ordinary General Public License for many libraries. However, the Lesser license provides advantages in certain special circumstances.

For example, on rare occasions, there may be a special need to encourage the widest possible use of a certain library, so that it becomes a de-facto standard. To achieve this, non-free programs must be allowed to use the library. A more frequent case is that a free library does the same job as widely used non-free libraries. In this case, there is little to gain by limiting the free library to free software only, so we use the Lesser General Public License.

In other cases, permission to use a particular library in non-free programs enables a greater number of people to use a large body of free software. For example, permission to use the GNU C Library in non-free programs enables many more people to use the whole GNU operating system, as well as its variant, the GNU/Linux operating system.

Although the Lesser General Public License is Less protective of the users' freedom, it does ensure that the user of a program that is linked with the Library has the freedom and the wherewithal to run that program using a modified version of the Library.

The precise terms and conditions for copying, distribution and modification follow. Pay close attention to the difference between a "work based on the library" and a "work that uses the library". The former contains code derived from the library, whereas the latter must be combined with the library in order to run.

TERMS AND CONDITIONS FOR COPYING, DISTRIBUTION AND MODIFICATION

0. This License Agreement applies to any software library or other program which contains a notice placed by the copyright holder or other authorized party saying it may be distributed under the terms of this Lesser General Public License (also called "this License"). Each licensee is addressed as "you".

A "library" means a collection of software functions and/or data prepared so as to be conveniently linked with application programs (which use some of those functions and data) to form executables.

The "Library", below, refers to any such software library or work which has been distributed under these terms. A "work based on the Library" means either the Library or any derivative work under copyright law: that is to say, a work containing the Library or a portion of it, either verbatim or with modifications and/or translated straightforwardly into another language. (Hereinafter, translation is included without limitation in the term "modification".)

"Source code" for a work means the preferred form of the work for making modifications to it. For a library, complete source code means all the source code for all modules it contains, plus any associated interface definition files, plus the scripts used to control compilation and installation of the library.

Activities other than copying, distribution and modification are not covered by this License; they are outside its scope. The act of running a program using the Library is not restricted, and output from such a program is covered only if its contents constitute a work based on the Library (independent of the use of the Library in a tool for writing it). Whether that is true depends on what the Library does and what the program that uses the Library does.

1. You may copy and distribute verbatim copies of the Library's complete source code as you receive it, in any medium, provided that you conspicuously and appropriately publish on each copy an appropriate copyright notice and disclaimer of warranty; keep intact all the notices that refer to this License and to the absence of any warranty; and distribute a copy of this License along with the Library.

You may charge a fee for the physical act of transferring a copy, and you may at your option offer warranty protection in exchange for a fee.

2. You may modify your copy or copies of the Library or any portion of it, thus forming a work based on the Library, and copy and distribute such modifications or work under the terms of Section 1 above, provided that you also meet all of these conditions:
- The modified work must itself be a software library.
 - You must cause the files modified to carry prominent notices stating that you changed the files and the date of any change.
 - You must cause the whole of the work to be licensed at no charge to all third parties under the terms of this License.
 - If a facility in the modified Library refers to a function or a table of data to be supplied by an application program that uses the facility, other than as an argument passed when the facility is invoked, then you must make a good faith effort to ensure that, in the event an application does not supply such function or table, the facility still operates, and performs whatever part of its purpose remains meaningful.

(For example, a function in a library to compute square roots has a purpose that is entirely well-defined independent of the application. Therefore, Subsection 2d requires that any application-supplied function or table used by this function must be optional: if the application does not supply it, the square root function must still compute square roots.)

These requirements apply to the modified work as a whole. If identifiable sections of that work are not derived from the Library, and can be reasonably considered independent and separate works in themselves, then this License, and its terms, do not apply to those sections when you distribute them as separate works. But when you distribute the same sections as part of a whole which is a work based on the Library, the distribution of the whole must be on the terms of this License, whose permissions for other licensees extend to the entire whole, and thus to each and every part regardless of who wrote it.

Thus, it is not the intent of this section to claim rights or contest your rights to work written entirely by you; rather, the intent is to exercise the right to control the distribution of derivative or collective works based on the Library.

In addition, mere aggregation of another work not based on the Library with the Library (or with a work based on the Library) on a volume of a storage or distribution medium does not bring the other work under the scope of this License.

3. You may opt to apply the terms of the ordinary GNU General Public License instead of this License to a given copy of the Library. To do this, you must alter all the notices that refer to this License, so that they refer to the ordinary GNU General Public License, version 2, instead of to this License. (If a newer version than version 2 of the ordinary GNU General Public License has appeared, then you can specify that version instead if you wish.) Do not make any other change in these notices.

Once this change is made in a given copy, it is irreversible for that copy, so the ordinary GNU General Public License applies to all subsequent copies and derivative works made from that copy.

This option is useful when you wish to copy part of the code of the Library into a program that is not a library.

4. You may copy and distribute the Library (or a portion or derivative of it, under Section 2) in object code or executable form under the terms of Sections 1 and 2 above provided that you accompany it with the complete corresponding machine-readable source code, which must be distributed under the terms of Sections 1 and 2 above on a medium customarily used for software interchange.

If distribution of object code is made by offering access to copy from a designated place, then offering equivalent access to copy the source code from the same place satisfies the requirement to distribute the source code, even though third parties are not compelled to copy the source along with the object code.

5. A program that contains no derivative of any portion of the Library, but is designed to work with the Library by being compiled or linked with it, is called a "work that uses the Library". Such a work, in isolation, is not a derivative work of the Library, and therefore falls outside the scope of this License.

However, linking a "work that uses the Library" with the Library creates an executable that is a derivative of the Library (because it contains portions of the Library), rather than a "work that uses the library". The executable is therefore covered by this License. Section 6 states terms for distribution of such executables.

When a "work that uses the Library" uses material from a header file that is part of the Library, the object code for the work may be a derivative work of the Library even though the source code is not. Whether this is true is especially significant if the work can be linked without the Library, or if the work is itself a library. The threshold for this to be true is not precisely defined by law.

If such an object file uses only numerical parameters, data structure

layouts and accessors, and small macros and small inline functions (ten lines or less in length), then the use of the object file is unrestricted, regardless of whether it is legally a derivative work. (Executables containing this object code plus portions of the Library will still fall under Section 6.)

Otherwise, if the work is a derivative of the Library, you may distribute the object code for the work under the terms of Section 6. Any executables containing that work also fall under Section 6, whether or not they are linked directly with the Library itself.

6. As an exception to the Sections above, you may also combine or link a "work that uses the Library" with the Library to produce a work containing portions of the Library, and distribute that work under terms of your choice, provided that the terms permit modification of the work for the customer's own use and reverse engineering for debugging such modifications.

You must give prominent notice with each copy of the work that the Library is used in it and that the Library and its use are covered by this License. You must supply a copy of this License. If the work during execution displays copyright notices, you must include the copyright notice for the Library among them, as well as a reference directing the user to the copy of this License. Also, you must do one of these things:

- Accompany the work with the complete corresponding machine-readable source code for the Library including whatever changes were used in the work (which must be distributed under Sections 1 and 2 above); and, if the work is an executable linked with the Library, with the complete machine readable "work that uses the Library", as object code and/or source code, so that the user can modify the Library and then relink to produce a modified executable containing the modified Library. (It is understood that the user who changes the contents of definitions files in the Library will not necessarily be able to recompile the application to use the modified definitions.)
- Use a suitable shared library mechanism for linking with the Library. A suitable mechanism is one that (1) uses at run time a copy of the library already present on the user's computer system, rather than copying library functions into the executable, and (2) will operate properly with a modified version of the library, if the user installs one, as long as the modified version is interface-compatible with the version that the work was made with.
- Accompany the work with a written offer, valid for at least three years, to give the same user the materials specified in Subsection 6a, above, for a charge no more than the cost of performing this distribution.
- If distribution of the work is made by offering access to copy from a designated place, offer equivalent access to copy the above specified materials from the same place.
- Verify that the user has already received a copy of these materials or that you have already sent this user a copy.

For an executable, the required form of the "work that uses the Library" must include any data and utility programs needed for reproducing the executable from it. However, as a special exception, the materials to be distributed need not include anything that is normally distributed (in either source or binary form) with the major components (compiler, kernel, and so on) of the operating system on which the executable runs, unless that component itself accompanies the executable.

It may happen that this requirement contradicts the license restrictions of other proprietary libraries that do not normally accompany the operating system. Such a contradiction means you cannot use both them and the Library together in an executable that you distribute.

7. You may place library facilities that are a work based on the Library side-by-side in a single library together with other library facilities not covered by this License, and distribute such a combined library, provided that the separate distribution of the work based on the Library and of the other library facilities is otherwise permitted, and provided that you do these two things:

- Accompany the combined library with a copy of the same work based on the Library, uncombined with any other library facilities. This must be distributed under the terms of the Sections above.
- Give prominent notice with the combined library of the fact that part of it is a work based on the Library, and explaining where to find the accompanying uncombined form of the same work.

8. You may not copy, modify, sublicense, link with, or distribute the Library except as expressly provided under this License. Any attempt otherwise to copy, modify, sublicense, link with, or distribute the Library is void, and will automatically terminate your rights under this License. However, parties who have received copies, or rights, from you under this License will not have their licenses terminated so long as such parties remain in full compliance.

9. You are not required to accept this License, since you have not signed it. However, nothing else grants you permission to modify or distribute the Library or its derivative works. These actions are prohibited by law if you do not accept this License. Therefore, by modifying or distributing the Library (or any work based on the Library), you indicate your

acceptance of this License to do so, and all its terms and conditions for copying, distributing or modifying the Library or works based on it.

10. Each time you redistribute the Library (or any work based on the Library), the recipient automatically receives a license from the original licensor to copy, distribute, link with or modify the Library subject to these terms and conditions. You may not impose any further restrictions on the recipients' exercise of the rights granted herein. You are not responsible for enforcing compliance by third parties with this License.

11. If, as a consequence of a court judgment or allegation of patent infringement or for any other reason (not limited to patent issues), conditions are imposed on you (whether by court order, agreement or otherwise) that contradict the conditions of this License, they do not excuse you from the conditions of this License. If you cannot distribute so as to satisfy simultaneously your obligations under this License and any other pertinent obligations, then as a consequence you may not distribute the Library at all. For example, if a patent license would not permit royalty free redistribution of the Library by all those who receive copies directly or indirectly through you, then the only way you could satisfy both it and this License would be to refrain entirely from distribution of the Library.

If any portion of this section is held invalid or unenforceable under any particular circumstance, the balance of the section is intended to apply, and the section as a whole is intended to apply in other circumstances.

It is not the purpose of this section to induce you to infringe any patents or other property right claims or to contest validity of any such claims; this section has the sole purpose of protecting the integrity of the free software distribution system which is implemented by public license practices. Many people have made generous contributions to the wide range of software distributed through that system in reliance on consistent application of that system; it is up to the author/donor to decide if he or she is willing to distribute software through any other system and a licensee cannot impose that choice.

This section is intended to make thoroughly clear what is believed to be a consequence of the rest of this License.

12. If the distribution and/or use of the Library is restricted in certain countries either by patents or by copyrighted interfaces, the original copyright holder who places the Library under this License may add an explicit geographical distribution limitation excluding those countries, so that distribution is permitted only in or among countries not thus excluded. In such case, this License incorporates the limitation as if written in the body of this License.

13. The Free Software Foundation may publish revised and/or new versions of the Lesser General Public License from time to time. Such new versions will be similar in spirit to the present version, but may differ in detail to address new problems or concerns.

Each version is given a distinguishing version number. If the Library specifies a version number of this License which applies to it and "any later version", you have the option of following the terms and conditions either of that version or of any later version published by the Free Software Foundation. If the Library does not specify a license version number, you may choose any version ever published by the Free Software Foundation.

14. If you wish to incorporate parts of the Library into other free programs whose distribution conditions are incompatible with these, write to the author to ask for permission. For software which is copyrighted by the Free Software Foundation, write to the Free Software Foundation; we sometimes make exceptions for this. Our decision will be guided by the two goals of preserving the free status of all derivatives of our free software and of promoting the sharing and reuse of software generally.

NO WARRANTY

15. BECAUSE THE LIBRARY IS LICENSED FREE OF CHARGE, THERE IS NO WARRANTY FOR THE LIBRARY, TO THE EXTENT PERMITTED BY APPLICABLE LAW. EXCEPT WHEN OTHERWISE STATED IN WRITING THE COPYRIGHT HOLDERS AND/OR OTHER PARTIES PROVIDE THE LIBRARY "AS IS" WITHOUT WARRANTY OF ANY KIND, EITHER EXPRESSED OR IMPLIED, INCLUDING, BUT NOT LIMITED TO, THE IMPLIED WARRANTIES OF MERCHANTABILITY AND FITNESS FOR A PARTICULAR PURPOSE. THE ENTIRE RISK AS TO THE QUALITY AND PERFORMANCE OF THE LIBRARY IS WITH YOU. SHOULD THE LIBRARY PROVE DEFECTIVE, YOU ASSUME THE COST OF ALL NECESSARY SERVICING, REPAIR OR CORRECTION.

16. IN NO EVENT UNLESS REQUIRED BY APPLICABLE LAW OR AGREED TO IN WRITING WILL ANY COPYRIGHT HOLDER, OR ANY OTHER PARTY WHO MAY MODIFY AND/OR REDISTRIBUTE THE LIBRARY AS PERMITTED ABOVE, BE LIABLE TO YOU FOR DAMAGES, INCLUDING ANY GENERAL, SPECIAL, INCIDENTAL OR CONSEQUENTIAL DAMAGES ARISING OUT OF THE USE OR INABILITY TO USE THE LIBRARY (INCLUDING BUT NOT LIMITED TO LOSS OF DATA OR DATA BEING RENDERED INACCURATE OR LOSSES SUSTAINED BY YOU OR THIRD PARTIES OR A FAILURE OF THE LIBRARY TO OPERATE WITH ANY OTHER SOFTWARE), EVEN IF SUCH HOLDER OR OTHER PARTY HAS BEEN ADVISED OF THE POSSIBILITY OF SUCH DAMAGES.

END OF TERMS AND CONDITIONS

How to Apply These Terms to Your New Libraries

If you develop a new library, and you want it to be of the greatest possible use to the public, we recommend making it free software that everyone can redistribute and change. You can do so by permitting redistribution under these terms (or, alternatively, under the terms of the ordinary General Public License).

To apply these terms, attach the following notices to the library. It is safest to attach them to the start of each source file to most effectively convey the exclusion of warranty; and each file should have at least the "copyright" line and a pointer to where the full notice is found. one line to give the library's name and an idea of what it does.

Copyright (C) year name of author

This library is free software; you can redistribute it and/or modify it under the terms of the GNU Lesser General Public License as published by the Free Software Foundation; either version 2.1 of the License, or (at your option) any later version.

This library is distributed in the hope that it will be useful, but WITHOUT ANY WARRANTY; without even the implied warranty of MERCHANTABILITY or FITNESS FOR A PARTICULAR PURPOSE. See the GNU Lesser General Public License for more details.

You should have received a copy of the GNU Lesser General Public License along with this library; if not, write to the Free Software Foundation, Inc., 51 Franklin Street, Fifth Floor, Boston, MA 02110-1301 USA Also add information on how to contact you by electronic and paper mail.

You should also get your employer (if you work as a programmer) or your school, if any, to sign a "copyright disclaimer" for the library, if necessary. Here is a sample; alter the names:

Yoyodyne, Inc., hereby disclaims all copyright interest in the library "Frob" (a library for tweaking knobs) written by James Random Hacker.
signature of Ty Coon, 1 April 1990 Ty Coon, President of Vice.



Hanwha Techwin cares for the environment at all product manufacturing stages, and is taking measures to provide customers with more environmentally friendly products. The Eco mark represents Hanwha Techwin's devotion to creating environmentally friendly products, and indicates that the product satisfies the EU RoHS Directive.



Correct Disposal of This Product (Waste Electrical & Electronic Equipment)

(Applicable in the European Union and other European countries with separate collection systems)

This marking on the product, accessories or literature indicates that the product and its electronic accessories (e.g. charger, headset, USB cable) should not be disposed of with other household waste at the end of their working life. To prevent possible harm to the environment or human health from uncontrolled waste disposal, please separate these items from other types of waste and recycle them responsibly to promote the sustainable reuse of material resources.

Household users should contact either the retailer where they purchased this product, or their local government office, for details of where and how they can take these items for environmentally safe recycling.

Business users should contact their supplier and check the terms and conditions of the purchase contract. This product and its electronic accessories should not be mixed with other commercial wastes for disposal.



Correct disposal of batteries in this product

(Applicable in the European Union and other European countries with separate battery return systems.)

This marking on the battery, manual or packaging indicates that the batteries in this product should not be disposed of with other household waste at the end of their working life. Where marked, the chemical symbols Hg, Cd or Pb indicate that the battery contains mercury, cadmium or lead above the reference levels in EC Directive 2006/66. If batteries are not properly disposed of, these substances can cause harm to human health or the environment.

To protect natural resources and to promote material reuse, please separate batteries from other types of waste and recycle them through your local, free battery return system.

Head Office

6, Pangyo-ro 319 beon-gil, Bundang-gu, Seongnam-si,
Gyeonggi-do, 463-400 Rep. of KOREA
Tel : +82.1588.5772 Fax : +82.31.8018.3740
www.wisenetlife.com

Hanwha Techwin America

500 Frank W. Burr Blvd. Suite 43 Teaneck, NJ 07666
Tel +1.844 WISENET (844.947.3638)
E-mail : cs@wisenetlife.com
www.wisenetlife.com

Hanwha Techwin Europe

Heriot House, Heriot Road, Chertsey, Surrey, KT16 9DT, United Kingdom
Tel : 00800.8010.8022 / +31.(0)13.5792.790
www.hanwha-security.eu
