

SAMSUNG
WISENET

1080p HD Analog Dome Camera User Manual

SDC-9443DF

CE

1080p HD Analog Bullet Camera

User Manual

Copyright

©2016 Hanwha Techwin Co., Ltd. All rights reserved.

Trademark

Each of trademarks herein is registered. The name of this product and other trademarks mentioned in this manual are the registered trademark of their respective company.

Restriction

Copyright of this document is reserved. Under no circumstances, this document shall be reproduced, distributed or changed, partially or wholly, without formal authorization.

Disclaimer

Hanwha Techwin makes the best to verify the integrity and correctness of the contents in this document, but no formal guarantee shall be provided. Use of this document and the subsequent results shall be entirely on the user's own responsibility. Hanwha Techwin reserves the right to change the contents of this document without prior notice.

❖ Design and specifications are subject to change without prior notice.

IMPORTANT SAFETY INSTRUCTIONS

1. Read these instructions.
2. Keep these instructions.
3. Heed all warnings.
4. Follow all instructions.
5. Do not use this apparatus near water.
6. Clean the contaminated area on the product surface with a soft, dry cloth or a damp cloth. (Do not use a detergent or cosmetic products that contain alcohol, solvents or surfactants or oil constituents as they may deform or cause damage to the product.)
7. Do not block any ventilation openings, Install in accordance with the manufacturer's instructions.
8. Do not install near any heat sources such as radiators, heat registers, stoves, or other apparatus (including amplifiers) that produce heat.
9. Do not defeat the safety purpose of the polarized or grounding-type plug. A polarized plug has two blades with one wider than the other. A grounding type plug has two blades and a third grounding prong. The wide blade or the third prong are provided for your safety. If the provided plug does not fit into your outlet, consult an electrician for replacement of the obsolete outlet.
10. Protect the power cord from being walked on or pinched particularly at plugs, convenience receptacles, and the point where they exit from the apparatus.
11. Only use attachments/ accessories specified by the manufacturer.
12. Use only with the cart, stand, tripod, bracket, or table specified by the manufacturer, or sold with the apparatus. When a cart is used, use caution when moving the cart/ apparatus combination to avoid injury from tip-over.
13. Unplug this apparatus during lightning storms or when unused for long periods of time.
14. Refer all servicing to qualified service personnel. Servicing is required when the apparatus has been damaged in any way, such as power-supply cord or plug is damaged, liquid has been spilled or objects have fallen into the apparatus, the apparatus has been exposed to rain or moisture, does not operate normally, or has been dropped.



overview

SAFETY PRECAUTIONS



CAUTION

RISK OF ELECTRIC SHOCK.
DO NOT OPEN



CAUTION : TO REDUCE THE RISK OF ELECTRIC SHOCK, DO NOT REMOVE COVER (OR BACK) NO USER SERVICEABLE PARTS INSIDE. REFER SERVICING TO QUALIFIED SERVICE PERSONNEL.



This symbol indicates that dangerous voltage consisting a risk of electric shock is present within this unit.



This exclamation point symbol is intended to alert the user to the presence of important operating and maintenance (servicing) instructions in the literature accompanying the appliance.

WARNING

- To reduce the risk of fire or electric shock, do not expose this appliance to rain or moisture.
- To prevent injury, this apparatus must be securely attached to the floor/wall in accordance with the installation instructions.

WARNING

1. Be sure to use only the standard adapter that is specified in the specification sheet. Using any other adapter could cause fire, electrical shock, or damage to the product.
2. Incorrectly connecting the power supply or replacing battery may cause explosion, fire, electric shock, or damage to the product.
3. Do not connect multiple cameras to a single adapter. Exceeding the capacity may cause abnormal heat generation or fire.
4. Securely plug the power cord into the power receptacle. Insecure connection may cause fire.
5. When installing the camera, fasten it securely and firmly. The fall of camera may cause personal injury.
6. Do not place conductive objects (e.g. screwdrivers, coins, metal parts, etc.) or containers filled with water on top of the camera. Doing so may cause personal injury due to fire, electric shock, or falling objects.
7. Do not install the unit in humid, dusty, or sooty locations. Doing so may cause fire or electric shock.
8. If any unusual smells or smoke come from the unit, stop using the product. In such case, immediately disconnect the power source and contact the service center. Continued use in such a condition may cause fire or electric shock.
9. If this product fails to operate normally, contact the nearest service center. Never disassemble or modify this product in any way. (Hanwha Techwin is not liable for problems caused by unauthorized modifications or attempted repair.)
10. When cleaning, do not spray water directly onto parts of the product. Doing so may cause fire or electric shock.

CAUTION

1. Do not drop objects on the product or apply strong shock to it. Keep away from a location subject to excessive vibration or magnetic interference.
2. Do not install in a location subject to high temperature, low temperature, or high humidity. Doing so may cause fire or electric shock.
3. If you want to relocate the already installed product, be sure to turn off the power and then move or reinstall it.
4. Remove the power plug from the outlet when there is a lightning. Neglecting to do so may cause fire or damage to the product.
5. Keep out of direct sunlight and heat radiation sources. It may cause fire.
6. Install it in a place with good ventilation.
7. Avoid aiming the camera directly towards extremely bright objects such as sun, as this may damage the CMOS image sensor.
8. Apparatus shall not be exposed to dripping or splashing and no objects filled with liquids, such as vases, shall be placed on the apparatus.
9. The Mains plug is used as a disconnect device and shall stay readily operable at any time.
10. Do not expose the camera to radioactivity. Radioactivity exposure may damage the CMOS.



Apparatus shall not be exposed to dripping or splashing and no objects filled with liquids, such as vases, shall be placed on the apparatus

overview

CONTENTS

OVERVIEW	3	Important Safety Instructions
	4	Safety Precautions
	6	Contents
	7	Product Features
	8	Part Names and Functions

3

INSTALLATION	9	Before Installation
---------------------	----------	---------------------

9

CONNECTION AND INSTALLATION	11	Connection of DVR and monitor
	11	Power connection
	12	Use of Communication
	12	Connection and Installation

11

CAMERA OPERATIONS	13	Camera Menus
	13	Main menu

13

APPENDIX	22	Product Specification
	24	Product Overview
	25	Troubleshooting

22

PRODUCT FEATURES

- **High resolution**

Use the 2 mega-pixel CMOS, and provide high resolution equivalent to 900TVL horizontal resolution.

- **High sensitivity**

The built-in high sensitive COLOR CMOS can produce a clear image. 0Lux (Auto IR LED On)

- **D-WDR (Digit Wide Dynamic Range)**

With the OV2710 CMOS sensor, this camera can provide a clear and quality image even under the circumstance of backlight, by way of and accurate exposure for the dark area and reducing exposure for the bright area: resulting in a clear, detailed and accurate image.

- **Other Features**

HLC, BLC, V-Flip/Mirror/Rotate, Sharpness and Privacy Zone.

- **Communication**

Support Coax (UTC) Communication.

- **OSD**

There are 8 languages available for the camera OSD.

- English, German, Italian, French, Spanish, Russian, Turkish and Portuguese

Package Contents

Check if the product package includes the following items.



SDC-9443DF

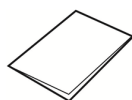

User Manual



Screw



Anchor



60ft Camera Cable



- The appearance of the components may differ from the image shown.
- Depending on the model you purchased, there may be difference in the type and number of accessory.

overview

PART NAMES AND FUNCTIONS

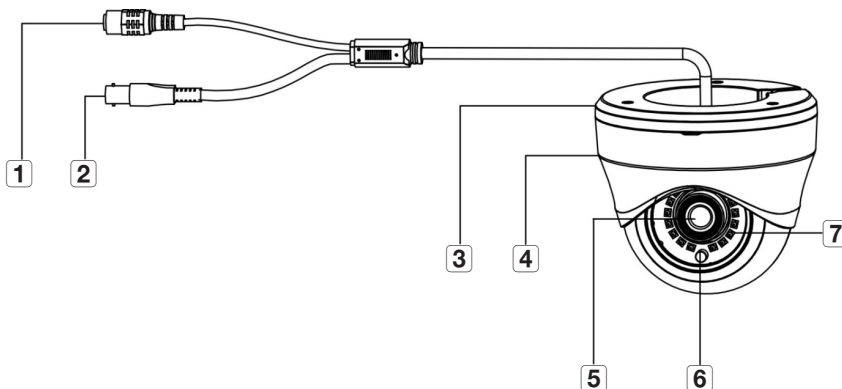

Item	Description
1	Power input terminal: Connect the power as specified. (DC 12V)
2	VIDEO OUTPUT jack: Video signals are output through this port. Connect this port to the Video IN port of an AHD DVR.
3	Bottom Cover
4	Top Cover
5	Lens: 3.6mm focal length enables you to monitor at a wider field of view.
6	Illumination Sensor: Detects incoming light to control the IR LED.
7	IR LED: Infrared LED lights are controlled by the illumination sensor.

installation

BEFORE INSTALLATION

Ensure you read out the following instructions before installing the camera:

- You have to check whether the location (ceiling or wall) can bear five times the weight of your camera.
- Don't let the cable to be caught in improper place or the electric line cover to be damaged. Otherwise it may cause a breakdown or fire.
- When installing your camera, don't allow any person to approach the installation site. If you have any important issue to be dealt with at the site, please do move the camera away to avoid any damage or injury.

Disassembly

Put a minus screw driver with a 3mm to 6mm width head to any groove part of the camera and rotate 45° to separate Bottom Cover and Top Cover.

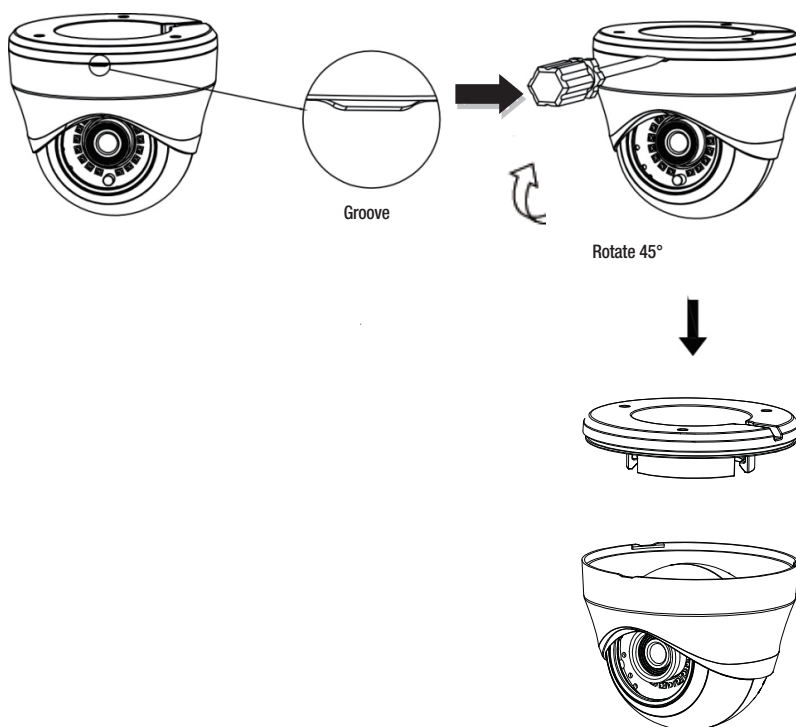

installation

Installation

1. Select installation site. Fix the Bottom cover to the wall or ceiling by using the 3 screws attached.
2. Connect DC 12V power supply to the camera.
3. Adjust camera position to make sure it points to the area you would like to monitor.

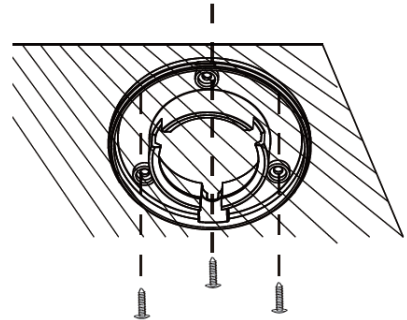

4. Connect and fix the Top cover and main body to the Bottom cover.



- Please mind the installation position.
- Please do not touch the camera lens to avoid any dirt and dust

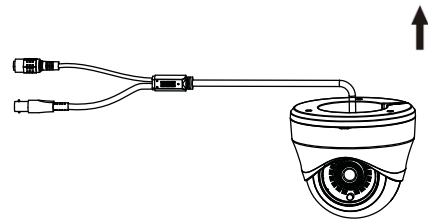

connection and installation

CONNECTION OF DVR AND MONITOR

Connect the video output jack of the camera to the video input jack of DVR and monitor.

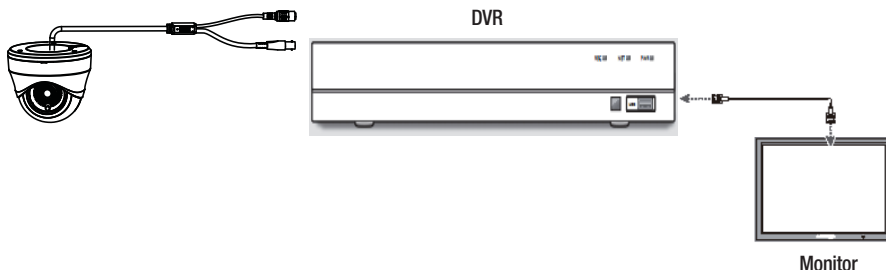

- Please refer to the manual attached with the device as the connection method varies from device to device.
- Turn off the power when connecting the power cord.

POWER CONNECTION

The power supply can be connected as shown below.

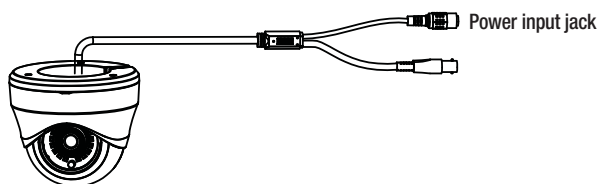

Resistance value of the copper wire when the temperature is [20° C(68° F)]

Copper wire size (AWG)	#24 (0.22mm ²)	#22 (0.33mm ²)	#20 (0.52mm ²)	#18 (0.83mm ²)
Resistance (Ω/m)	0.078	0.050	0.030	0.018
Voltage drops (V/m)	0.028	0.018	0.011	0.006

- As shown in the table, the voltage will be reduced when the connection line becomes longer. Therefore, it may affect the camera performance if a very long adapter output line is connected to the camera.
 - Standard voltage for the operation of the camera: DC 12V±10%
 - There may be some deviations in the voltage drop, subject to the connection line type and manufacturer.



- Only connect it to the power supply after completing all the installation.

connection and installation

USE OF COMMUNICATION

- Coaxial communication system

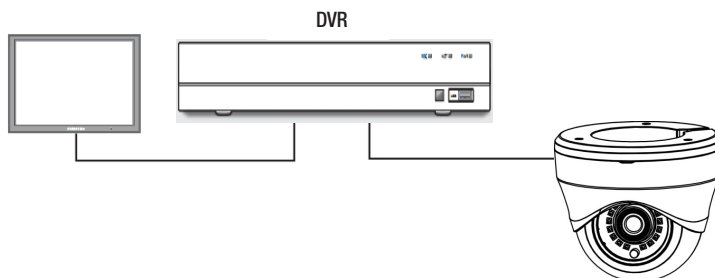

CONNECTION AND INSTALLATION

Video cable

Connect the video output jack of the camera to the monitor with BNC coaxial cable, as shown below: Please use an auxiliary video amplifier if the distance between the camera and monitor exceeds the recommended maximum value.

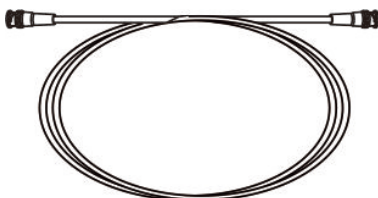

Distance	Recommended cable specification
500m	5C2V
300m	3C2V









- It is recommended to use the pure copper coaxial cable instead of the copper-clad iron cable, otherwise, it will result in problems of the communication via the coaxial cable.
- To guarantee the image quality, only use single-channel video output connector when connecting the camera to other video equipment.

camera operations

CAMERA MENUS

1. Open DVR main menu, and go to Device → PTZ → Protocol. (Based on DVR SDR-B73303/SDR-B74303/SDR-B75303) Set Coax as Protocol.
2. Go to live view interface, left click on the live channel and select the PTZ control icon [] to have the following interface.



- 
 - Click the icon [] to go to AHD camera OSD menu. This icon is also to be used as Confirm icon. Up, down and right and left buttons [, , , ] are used to select the menu. The display menu may be different for different DVRs.
 - Item with <  > icon includes submenu. You can go to the sub menu and do the settings.
 - The item with < - - - > icon is not available due to function setting.

MAIN MENU

EXPOSURE

< MAIN MENU > ➔ < EXPOSURE >

MAIN MENU	
1.EXPOSURE	↵
2.BACKLIGHT	OFF
3.WHITE BAL	ATW
4.NR	↵
5.SPECIAL	↵
6.ADJUST	↵
7.EXIT	SAVE&END↵

EXPOSURE	
1.SHUTTER	AUTO
2.AGC13
3.SENS-UP	OFF
4.BRIGHTNESS34
5.D-WDR	OFF
6.DEFOG	OFF
7.RETURN	RET↵

SHUTTER

- NTSC : AUTO / FLK / 1/50,000sec~1/30sec / X2 ~ X30;
- PAL : AUTO / FLK / 1/50,000sec~1/25sec / X2 ~ X30
- AUTO : Indicate automatically adjusting the shutter according to the light.
- FLK : Anti-flicker. It is used in special scenarios, such as under the fluorescent lamp.

- 
 - The larger the shutter value, the brighter the image, but the bigger the after image of the moving object. When the shutter value is small, there will be Noise, Spots and whiting, which is normal.

camera operations

AGC

0-15 optional. The higher the gain level, the brighter the screen, but the more the noise.

SENS-UP

AUTO/OFF. When it is set as AUTO, the higher the frame accumulation, the brighter the image, and the lower the frame rate under a low-luminance environment.

BRIGHTNESS

0-100 is optional, and the larger the value, the brighter the image.

D-WDR

When there are both the bright and dark areas, this function can help you see clear each part on the screen. Adjust the level as needed, to adjust the image brightness of D-WDR.

D-WDR	
1.LEVEL2
2.RETURN	RET↵

- LEVEL : Level 0 to 8 optional. And the higher the level, the brighter the dark object.
- RETURN : RET/SAVE&END.



DEFOG

DEFOG	
1.POS/SIZE	↵
2.GRADATION0
3.DEFAULT	↵
4.RETURN	RET↵

- POS/SIZE : POSITION and SIZE of setting area.
- GRADATION : Level 0 to 2 is optional. Higher the level, defog effect will be better.
- DEFAULT : Restore to default settings.
- RETURN : RET/SAVE&END



- The camera can automatically identify the fog density in the image with defog function, and it can vividly display the image even when the sight cannot be guaranteed to be clear as affected by the darkness or haze.

BACKLIGHT

< MAIN MENU > ➔ < BACKLIGHT (OFF/BLC/HLC) >

It will adjust automatically, therefore, you can distinguish the object and the background and select the required area in the image to view it more clearly even in a lighting scene with serious backlight.

BLC

BLC	
1.LEVEL	MIDDLE
2.AREA	↵
3.DEFAULT	↵
4.RETURN	RET↵

- LEVEL : Backlight compensation level setting LOW/MIDDLE/HIGH
- AREA : Backlight compensation setting, with the area POSITION and SIZE settable.
- DEFAULT : Restore defaults
- RETURN : RET/SAVE&END

HLC

The function can shield strong light, reduce the white color due to overexposure and reserve more screen detailed information when the camera aligns to the strong light source.

HLC	
1.SELECT	AREA1
2.DISPLAY	ON↵
3.BLACK MASK	ON
4.LEVEL20
5.MODE	NIGHT↵
6.DEFAULT	↵
7.RETURN	RET↵

- SELECT: Selection of setting area (AREA1 TO AREA4)
- DISPLAY: POSITION and SIZE of setting area.
- BLACK MASK: Switch of setting area
- LEVEL: Strong light inhibition level (0-100). The strong light inhibition is more obvious with higher level.
- MODE: Strong light inhibition mode (NIGHT/ALL DAY).
- DEFAULT: Restore defaults.
- RETURN: RET/SAVE&END



- If the white balance menu is manual mode, the performance of HLC may be limited to some extent. Saturation phenomenon may occur in the bright environment if the functions of Defog and HLC are used simultaneously. The efficiency of HLC may be different according to the ray of light in the bright area of screen, so it is better to optimize the installation angle for achieving optimal HLC performance.

camera operations

WHITE BAL

< MAIN MENU > → < WHITE BAL (ATW/AWC → SET/INDOOR/OUTDOOR/MANUAL/AWB) >

- ATW : When the color temperature is between 1,800K° and 10,500K°, set as ATW.
- AWC → SET : Set the white balance manually according to the current color temperature.
- INDOOR : When the color temperature is between 4,500K° and 8,500K°, set as INDOOR. Adjust the white balance to optimize the color of camera in the indoor environment.
- OUTDOOR: The color temperature is between 1,800K°~10,500K°. (Including sodium lamp) To enable the camera to restore the original color correctly in the outdoor environment, the white balance shall be adjusted.
- MANUAL : Choose “MANUAL” to adjust the white balance manually.

MANUAL WB	
1.BLUE50
2.RED50
3.RETURN	RET↵

- BLUE : 0-100 (optional). The larger the value, the bluer the image.
- RED : 0-100 (optional). The larger the value, the redder the image.
- RETURN : RET/SAVE&END
- AWB : Back to normal color under special scenario, such as under tungsten filament lamp, or fluorescent lamp.
In this case, “white balance” cannot work normally.



- In following cases, please choose the “AWB” mode.
- When the color temperature of the object surroundings exceeds the control range (such as clear sky or sunset), choose the item.
- When the ambient light illumination of the subject is dark, if the camera faces towards the fluorescent lamp or installed in a place where the illumination changes significantly, the operation of “white balance” may be unstable.

NR (Noise Reduction)

< MAIN MENU > ➔ < NR >

The function is to reduce the image noise. The noise reduction level can be set according to the actual situation of image. At the same time. The higher the level, the noise reduction effect is better.

NR	
1.2DNR	MIDDLE
2.3DNR	MIDDLE
3.RETURN	RET↵

- 2DNR : 2D noise reduction, OFF/LOW/MIDDLE/HIGH
- 3DNR : 3D noise reduction, OFF/LOW/MIDDLE/HIGH
- RETURN : RET/SAVE&END

SPECIAL

< MAIN MENU > ➔ < SPECIAL >

SPECIAL	
1.CAM TITLE	OFF↵
2.D-EFFECT	↵
3.MOTION	OFF↵
4.PRIVACY	OFF↵
5.OUTPUT	AHD↵
6.LANGUAGE	ENG↵
7.RETURN	RET↵

CAM TITLE

Set to ON, move to the position of character you choose through the menu option key [▲ ▼ ◀ ▶] (Left, Right, Up and Down keys), and click [■] to confirm. Repeat the step to input more characters. 15 characters can be entered at most.

- ← → : Move to the left or right till to the position of input character.
- CLR : Clear the input character.
- POS : Move the position of camera title through the menu option key [▲ ▼ ◀ ▶] (Left, Right, Up and Down keys).
- END : Return to the previous menu.

CAM TITLE	
0 1 2 3 4 5 6 7 8 9	
A B C D E F G H I J K	
L M N O P Q R S T U V	
W X Y Z ▶▶◀◀↑↓ ()	
- _ # / =& : ~ , .	
◀ ▶ CLR POS END	



camera operations

D-EFFECT

D-EFFECT	
1.FREEZE	OFF
2.MIRROR	OFF
3.RETURN	RET↵

- FREEZE : ON/OFF. Choose ON which indicates the image cannot be rotated. OFF indicates the image can be rotated.
- MIRROR : OFF/MIRROR/V-FLIP/ROTATE
 - MIRROR : Rotate Horizontal
 - V-FLIP : Rotate Vertical
 - ROTATE : The image is rotated by 180 degrees
- RETURN: RET/SAVE&END.

MOTION (OFF/ON)

Whenever the illuminated object is detected to move in four areas of image, the product will send alarm so as to achieve effective monitoring.

MOTION	
1.SELECT	AREA1↵
2.DISPLAY	ON↵
3.SENSITIVITY64
4.COLOR	GREEN
5.TRANS.	1.00
6.ALARM	↵
7.DEFAULT	↵
8.RETURN	RET↵

- SELECT : 4 Areas optional.
- DISPLAY : Set the position and size of the Motion area.
- SENSITIVITY : Level 0-100 adjustable. The higher the level, the more sensitive it is.
- COLOR: The frame of detection area and the color in the frame can be set. GREEN/BLUE/WHITE/RED is optional.
- TRANS. : Adjust the color transparency in the frame of the motion detection area. 0.00/0.25/0.75/1.00 is optional, and the larger the value, the higher the transparency.

- ALARM : Alarm setting

ALARM	
1.VIEW TYPE	ALL
2.OSD VIEW	ON
3.TIME3
4.RETURN	RET↵

- VIEW TYPE : Optional alarm display modes of motion detection: ALL/OFF/BLOCK/OUTLINE can be selected.
 - BLOCK : After the MOTION alarm is triggered, the set MOTION area is displayed in a blocked area.
 - OUTLINE : After the MOTION alarm is triggered, the set MOTION area is displayed in a area with border.
 - ALL : After the MOTION alarm is triggered, the set MOTION area is displayed in a bordered grid area.
 - OFF : No alarm when MOTION is triggered.
- OSD VIEW : Alarm display switch of motion detection.
- TIME : Alarm time setting (0-15s)
- RETURN: RET/SAVE&END
- DEFAULT : Restore defaults
- RETURN : RET/SAVE&END



- The same settings of motion sensitivity apply to area both area 1&area 2 and area 3&area 4.
- The same settings of alarm and default under motion apply to all areas.

PRIVACY (OFF/ON)

PRIVACY	
1.SELECT	AREA1↵
2.DISPLAY	COLOR↵
3.COLOR	WHITE
4.TRANS.	1.00
5.DEFAULT	↵
6.RETURN	RET↵

- SELECT : AREA1 TO AREA4
- DISPLAY : OFF/MOSAIC/INV./COLOR
 - OFF : Turn off privacy zone setup.
 - MOSAIC : Background of privacy zone is mosaic.
 - INV. : Background of privacy zone looks like photographic film.
 - COLOR: Background of privacy zone in color.
Click to select the background type and set the position and size of privacy zone.

camera operations

- COLOR : Set the color in the privacy area.
WHITE/BLACK/BLUE/YELLOW/GREEN/CYAN is optional.
- TRANS : Adjust the color transparency in the frame of the motion detection area.
0.25/0.50/0.75/1.00 is optional, and the larger the value, the higher the transparency.
- DEFAULT : Default setting parameters
- RETURN: RET/SAVE&END

OUTPUT

Optional output mode: AHD and CVBS

LANGUAGE

Choose the language you need to set : ENG/GER/FRA/ITA/SPA/RUS/POR/TUR

RETURN

RET/SAVE&END



- When area of Motion and Privacy overlaps, if set color under Display and set 1 as Transparency under Privacy setup, overlapped area of privacy and motion will block the motion area, but it won't have an effect on motion alarm.

ADJUST (Image Adjustment)

< MAIN MENU > ➔ < ADJUST >

ADJUST	
1.SHARPNESS	AUTO↵
2.MONITOR	LCD↵
3.LSC	ON
4.RETURN	RET↵

SHARPNESS

AUTO/OFF is optional, and the larger the acutance, the higher the definition.

MONITOR

Color compensation of camera (LCD/CRT)

LSC

The lens shade is corrected and the periphery turns bright after starting.

RETURN

RET/SAVE&END



- In the following cases, the appear/indicator may malfunction.
 - Some random motion may occur continuously
 - Fixed object moves on the same position continuously
 - When a new object covers an object with changes.
- The identification size may have errors due to different shapes of the object.
- In the following cases, the motion detection and the image analysis alarm performance may be reduced or abnormal operation may occur.
 - The brightness or color of object may be similar to the background of image
 - The position of image frame may move slightly
 - Most motions occur continuously and randomly due to the influence of factors such as lens switching and rapid change of lighting
 - The motion of fixed object on the same position occurs continuously
 - Just like the object is close to the camera or keeps away from the camera, the position on the image may move slightly
 - The moving object approaches to the camera
 - Any object shields the objects different from each other
 - More than two objects combine or one object is separated into multiple
 - The motion of object is too fast (same objects have overlapping area between continuous frameworks)
 - Reflection, exhaust dyeing and shades occur due to strong light rays, such as direct light, lighting and automotive headlamp
 - Bad weather like snow, rain and wind or sunset/sunrise

Exit

< MAIN MENU > ➡ < Exit >

SAVE&END

Menu for current setting and exiting “Main Menu”.

NOT SAVE

Not save current setting and exiting “Main Menu”.

RESET

Restore the camera to the factory defaults. But the language and mode setting will not restore defaults.

appendix

PRODUCT SPECIFICATION

Item	Details	
	SDC-9443DFN	SDC-9443DFP
Video		
Imaging Device	1/2.7" 2M CMOS	
Total Pixels	1952 x 1092	
Effective Pixels	1920 x 1080	
Scanning System	Progressive Scan	
Min. Illumination	0 Lux (Auto IR LED on)	
S / N Ratio	52dB (AGC off)	
Video Output	BNC(AHD, CVBS Selectable) AHD : 30fps@1080p CVBS: 30fps@928*480	BNC(AHD, CVBS Selectable) AHD : 25fps@1080p CVBS: 25fps@928*576
Horizontal Resolution	Centre 900 TV lines, Corner 600 TV lines	
Lens Type		
Focal Length (Zoom Ratio)	3.6mm	
Max. Aperture Ratio	F2.1	
Angular Field of View	D:104.6°/H:88.9°/V:46.3°	
Min. Object Distance	0.5m (1.64ft)	
Focus Control	Fixed	
Operational		
IR LED	18ea LED	
Viewable length	20m (65.62ft)	
On Screen Display	Multi-language Support(8) : English, French, German, Spanish, Italian, Russian, Turkish, Portuguese	
Camera Title	Off / On (Displayed 15 characters)	
Day & Night	Auto(ICR)	
Backlight Compensation	Off / BLC / HLC	
Wide Dynamic Range	D-WDR	
Digital Noise Reduction	2D/3D DNR	

Item	Details	
	SDC-9443DFN	SDC-9443DFP
Defog	Off / On	
Motion Detection	Off / On(4 zones)	
Privacy Masking	Off / On (4 zones)	
Gain Control	AGC	
White Balance	ATW / AWB/ Outdoor / Indoor / Manual / AWC(1,800K°~10,500K°)	
Electronic Shutter Speed	AUTO / FLK / 1/50,000sec~1/30sec / X2 ~ X30	AUTO / FLK / 1/50,000sec~1/25sec / X2 ~ X30
Reverse	Off/Mirror/V-Flip/Rotate	
Protocol	ACP	
Video Transmission Distance	300m(3C-2V), 500m(5C-2V)	
Environmental		
Operating Temperature / Humidity	-10°C ~ +50°C (14°F ~ +122°F) / Less than 90% RH	
Electrical		
Input Voltage/Current	12VDC±10%	
Power Consumption	4.4W	
Mechanical		
Color / Material	White	
Dimension (ØxH)	Ø 100x H 89.6 mm	
Weight	0.184kg	

appendix

PRODUCT OVERVIEW

unit : mm(inch)

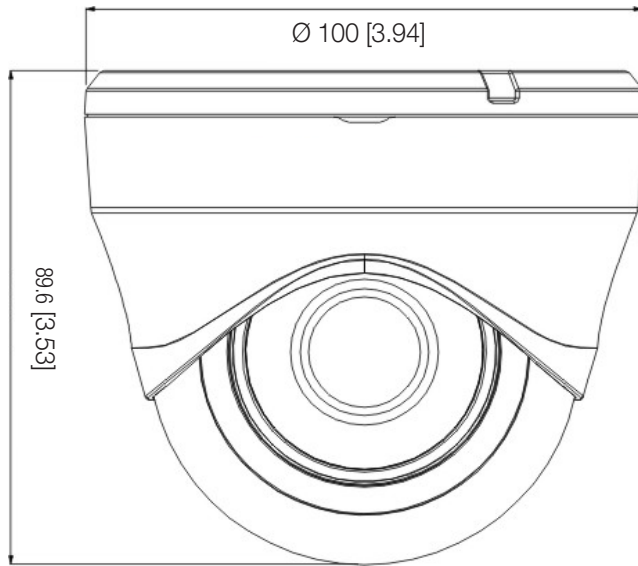

TROUBLESHOOTING

Please refer to the following table if you have problems during camera operation.

Please contact with the authorized technicians if your problem cannot be solved through the guidance.

Problem	Troubleshooting
There is no content displayed on the screen.	<ul style="list-style-type: none"> • Check whether the power cable and the cable between camera and monitor are connected correctly. • Check whether BNC cable is connected to the camera correctly. • Check if video system is the same as of DVR.
The image on the screen is dim.	<ul style="list-style-type: none"> • Whether the lens is stained with dust. Clean the lens with soft and clean cloth. • Set suitable condition for the monitor or DVR. • If the camera is pointed to the strong light, please change the position of camera.
The image on the screen is dark.	<ul style="list-style-type: none"> • Adjust the contrast ratio of monitor or DVR. • If there is intermediate equipment, please set 75Ω/Hi-z correctly.
The camera fails to work normally and the surface is hot.	<ul style="list-style-type: none"> • Please check whether the camera is connected to suitable power supply correctly.
The color is incorrect.	<ul style="list-style-type: none"> • Please check the setting of white balance setting menu.
The screen flickers constantly.	<ul style="list-style-type: none"> • Please ensure that the camera is not pointed to the sun.
When the coaxial communication is not available	<ul style="list-style-type: none"> • Please ensure that the camera and monitor are installed in the recommended distance. • If they exceed the recommended installation distance, please use coaxial and equivalent video amplifier.



Any changes or modifications in construction of this device which are not expressly approved by the party responsible for compliance could void the user's authority to operate the equipment.

This device complies with part 15 of the FCC Rules. Operation is subject to the following two conditions: (1) This device may not cause harmful interference, and (2) this device must accept any interference received, including interference that may cause undesired operation.

This equipment has been tested and found to comply with the limits for a Class A digital device, pursuant to part 15 of the FCC Rules. These limits are designed to provide reasonable protection against harmful interference when the equipment is operated in a commercial environment. This equipment generates, uses, and can radiate radio frequency energy and, if not installed and used in accordance with the instruction manual, may cause harmful interference to radio communications. Operation of this equipment in a residential area is likely to cause harmful interference in which case the user will be required to correct the interference at his own expense.



Hanwha Techwin cares for the environment at all product manufacturing stages, and is taking measures to provide customers with more environmentally friendly products.

The Eco mark represents Hanwha Techwin's devotion to creating environmentally friendly products, and indicates that the product satisfies the EU RoHS Directive.



Correct Disposal of This Product (Waste Electrical & Electronic Equipment)

(Applicable in the European Union and other European countries with separate collection systems)

This marking on the product, accessories or literature indicates that the product and its electronic accessories (e.g. charger, headset, USB cable) should not be disposed of with other household waste at the end of their working life. To prevent possible harm to the environment or human health from uncontrolled waste disposal, please separate these items from other types of waste and recycle them responsibly to promote the sustainable reuse of material resources.

Household users should contact either the retailer where they purchased this product, or their local government office, for details of where and how they can take these items for environmentally safe recycling.

Business users should contact their supplier and check the terms and conditions of the purchase contract. This product and its electronic accessories should not be mixed with other commercial wastes for disposal.



Correct disposal of batteries in this product

(Applicable in the European Union and other European countries with separate battery return systems.)

This marking on the battery, manual or packaging indicates that the batteries in this product should not be disposed of with other household waste at the end of their working life. Where marked, the chemical symbols Hg, Cd or Pb indicate that the battery contains mercury, cadmium or lead above the reference levels in EC Directive 2006/66. If batteries are not properly disposed of, these substances can cause harm to human health or the environment.

To protect natural resources and to promote material reuse, please separate batteries from other types of waste and recycle them through your local, free battery return system.

Head Office

86 Cheonggyecheon-ro Jung-gu Seoul 04541 Korea
Tel +82.2.729.5277, 5254 Fax +82.2.729.5489
www.hanwha-security.com

Hanwha Techwin America

500 Frank W. Burr Blvd. Suite 43 Teaneck, NJ 07666
Toll Free +1.877.213.1222 Direct +1.201.325.6920
Fax +1.201.373.0124

Hanwha Techwin Europe

Heriot House, Heriot Road, Chertsey, Surrey, KT16 9DT, United Kingdom
Tel +44.1932.57.8100 Fax +44.1932.57.8101
